



**POELSAN®**



POELSAN®

**ÜRÜN KATALOĞU**  
PRODUCT CATALOGUE

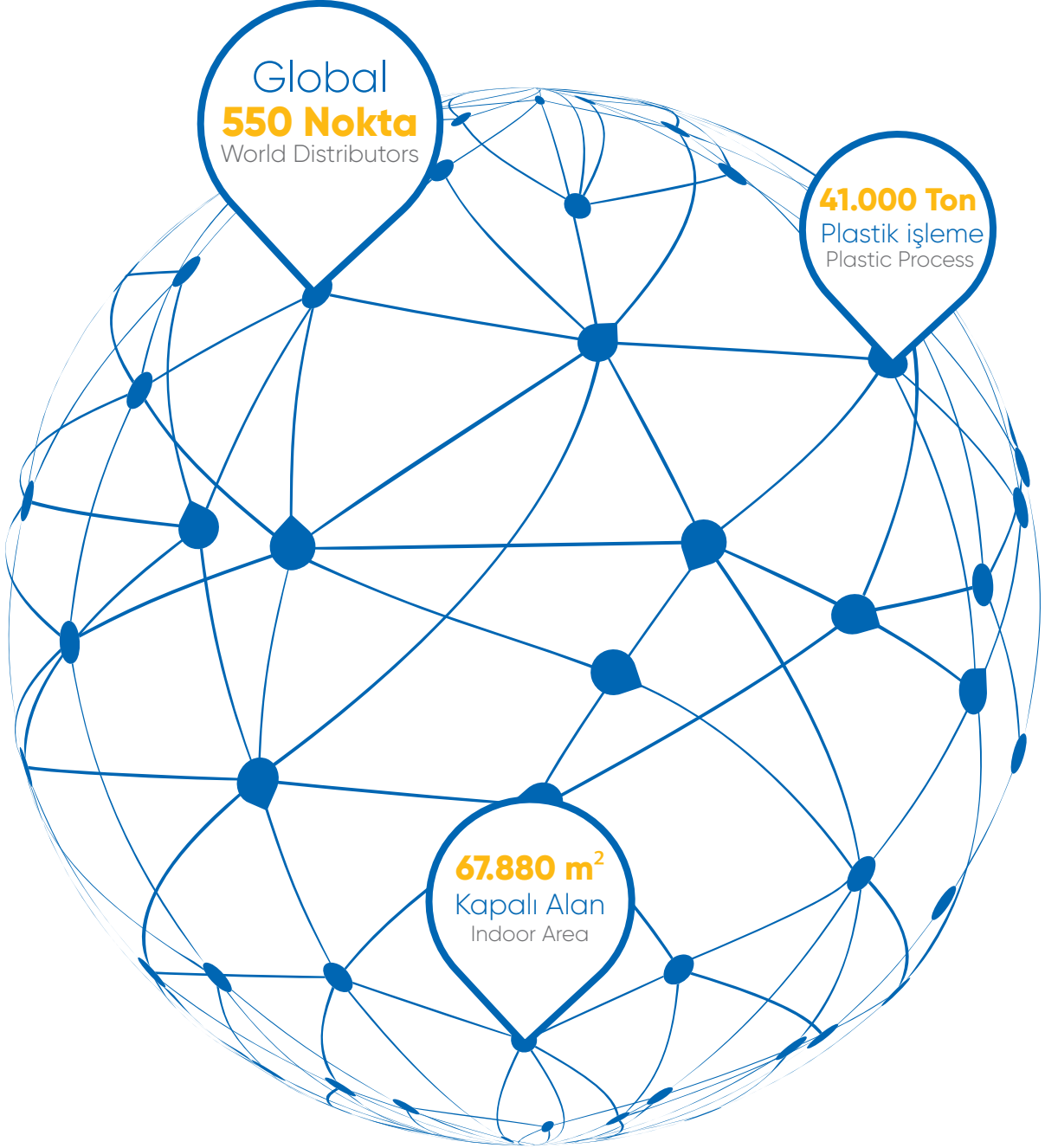

# Dünyanın Suyuna Yön Veriyoruz.

✦ Poelsan olarak çözüm odaklı ve yenilikçi bir anlayış ile peyzaj sektörü başta olmak üzere, içme suyu şebekelerinde, tarım alanlarında, seralarda, spor tesislerinde, damla sulama ve otomatik sulama sistemleri özelinde dünya standartlarında ürünler geliştiriyoruz.

2.000'in üzerinde ürün çeşidi ve geleceğe dost ürünler ile ses getiren projelere imzamızı atıyor, sahip olduğumuz uluslararası tecrübe, geniş hizmet, nitelikli insan kaynağı, bilgi ağı ve değer yaratan çalışmalarla 80'in üzerinde ülkeye ihracat gerçekleştiriyoruz.

30 yıllık başarı hikayemizde bugüne kadar değişmeyen önceliğimiz, tasarımdan başlayarak üretimin her aşamasında çevre dostu uygulamaları sürdürülebilir kılmaktır. Faaliyet gösterdiğimiz her sektörde bugünün değil geleceğin ürünlerine odaklanıyor, kalite ve güveni ilke edindiğimiz bir kültürle çalışıyoruz.

Dünya standartlarında son teknoloji ile geliştirdiğimiz yenilikçi ürünler ile verimliliğin artırılmasını hedefliyor, sektörün beklentilerine yönelik çözümler sağlıyoruz.

# We Direct the World's Water

✦ As Poelsan, we develop world-class products for drip irrigation and automatic irrigation systems, especially in the landscaping sector, water supply network, agricultural fields, greenhouses, sports facilities, with a solution-oriented and innovative approach.

With over 2,000 products range and future-friendly products, we are putting our signature to projects that make an impression, and we export to more than 80 countries with our international experience, broad service, qualified human resources, information network and value-creating works.

Our stationary priority in our 30-year success story is to make environmentally friendly practices sustainable at every stage of production, starting from design. In every sector in which we operate, we focus on the products of the future, not today, and work with a culture in which we adopt quality and trust as a principle.

We aim to increase productivity with innovative products that we have developed with the latest technology at world standards, and we provide solutions for the expectations of the sector.





## Misyonumuz

- + Teknolojiyi kullanarak yüksek kaliteli ve inovatif ürünler sunmak; bu ürünleri global pazar müşterileri ile buluşturmak.

## Vizyonumuz

- + Su sistemlerinde Dünya'da tanınan bir marka ve Türkiye sanayisinin öncü şirketlerinden birisi olmak.

## Değerlerimiz

- + İnsan ve Çevreye Saygı
- + Liderlik
- + Güvenilirlik
- + Değerli Hissettirmek
- + Gelişime ve Yeniliğe Açık
- + Takım Ruhu

## Our Mission

- + To offer high quality and innovative products using technology; to bring these products together with the global market customers.

## Our Vision

- + To become a well known world brand in the World in water systems and one of the leading companies in the Turkish industry.

## Our Values

- + Respect for Human and Environment
- + Leadership
- + Reliability
- + Making Feel Valuable
- + Open to Development and Innovation
- + Team Spirit





# DÜNYANIN SUYUNA YÖN VERİYORUZ

WE DIRECT THE WORLD'S WATER

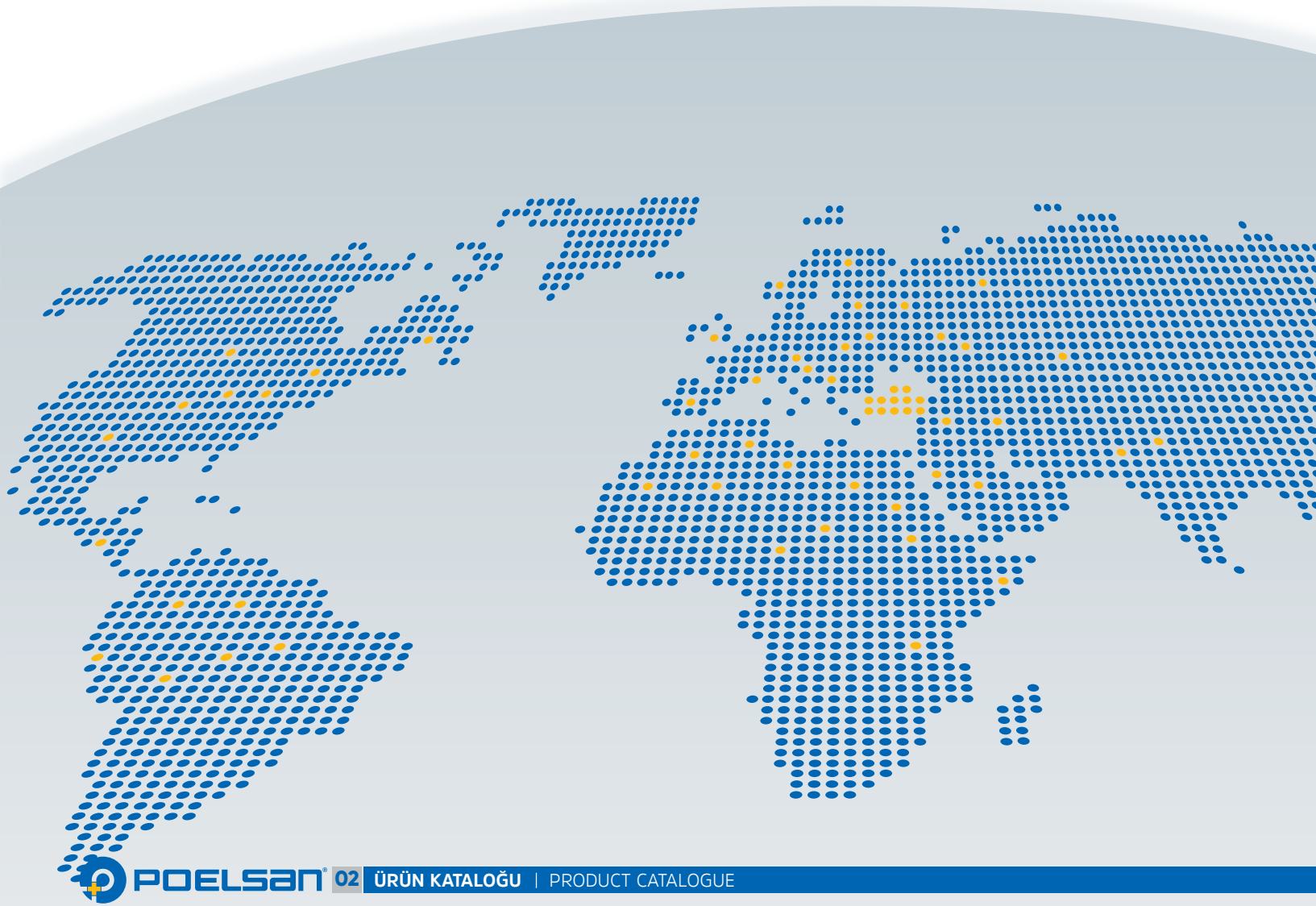



**80+** **3.000** Üzerinde **Ürün Çeşidi**  
**ÜLKEYE İHRACAT**

Over 3.000 range of products  
Exports to 80+ countries





# MEKANİK EKLEME PARÇALARI

## COMPRESSION FITTINGS



**MAVİ SERİ**  
BLUE SERIES

  
TS ISO 17885

08



**YEŞİL SERİ**  
GREEN SERIES

  
TS ISO 17885

22



**PRİZ KOLYE**  
CLAMP SADDLES

  
TS ISO 13460-1

39



**PRİZ KOLYE GEÇMELİ**  
CLAMP SADDLES WITH SLIDE

  
TS ISO 13460-1

53



**LAYFLAT EK PARÇALARI**  
LAYFLAT FITTINGS

56



**DİŞLİ BAĞLANTI ELEMANLARI**  
THREADED FITTINGS

63

# VANALAR ve VANA KUTULARI

## VALVES and VALVE BOXES



**MAVİ SERİ KÜRESEL VANA**  
BLUE SERIES BALL VALVES



70



**YEŞİL SERİ KÜRESEL VANA**  
GREEN SERIES BALL VALVES



72

**CAN SUYU VANA**  
QUICK COUPLING VALVE



75



**VANA KUTULARI**  
VALVE BOXES



77

# PLASTİK FİLTRELER

## PLASTIC FILTERS

**PLASTİK FİLTRELER**  
PLASTIC FILTERS



81



# DAMLA SULAMA EK PARÇALARI

## DRIPLINE FITTINGS

84



**MINİ VANA (DN 8)**

MINI VALVE (DN 8)



TS EN ISO 9261

98



**MINİ VANA (DN 15)**

MINI VALVE (DN 15)



TS EN ISO 9261

106



**HAT SONU TAHLİYE VANASI**

AUTOMATIC LINE FLUSH VALVES

109



**KİLİTLİ BAĞLANTI ELEMANLARI**

LOCK TYPE FITTINGS



TS EN ISO 9261

117



**DAMLA SULAMA KURTAĞZI**

DRIPLINE BARBED FITTINGS



TS EN ISO 9261

127



**DAMLA SULAMA SOMUNLU**

DRIPLINE FITTINGS



TS EN ISO 9261

# DAMLA SULAMA EK PARÇALARI

## DRIPLINE FITTINGS



TS EN ISO 9261

**YASSI DAMLA SULAMA SOMUNLU**  
DRIP TAPE FITTINGS



135



TS EN ISO 9261

**YASSI DAMLA SULAMA YÜZÜKLÜ**  
DRIP TAPE FITTINGS WITH RING



143

**MİNİSPRİNKLER VE EK PARÇALARI**  
MINISPRINKLERS & FITTINGS



150

**HAT ÜSTÜ DAMLATICI**  
ON - LINE DRIPPER



156

**ÖZEL ÜRETİMLERİMİZ**  
SPECIAL PRODUCTIONS

**RURAL SERİ**  
RURAL SERIES



160

**RURAL KÜRESEL VANA**  
RURAL BALL VALVE



167



## Özellikler

- + Darbelere karşı dayanıklı, yüksek kaliteli polipropilen hammaddeden üretilmiştir.
- + Borulardaki ölçü farklılıklarından veya ovalikten oluşabilecek sorunları konik sıkma özelliği sayesinde önler.
- + UV ışınlarını geçirmediği için yosunlanmaya ve bakteri üremesine izin vermez.
- + Oringi kauçuktan üretilmekte olup yüksek basınç altında sızdırmazlık sağlar.
- + İç yüzeyleri homojen ve gözeneksizdir.
- + Suyun kokusunu ve tadını değiştirebilecek zararlı bileşikler içermez.
- + Dişi ürünlerimiz, korozyona dayanıklı metal yüzük sayesinde değişken sıcaklıklarda yüksek sızdırmazlık sağlar.
- + Diş ölçüleri ISO 7-1 Standardına uygundur.
- + ISO 17885 Standardına uygundur.

## Specifications

- + It has been produced from high quality polypropylene raw material and it has resistance to impact.
- + Thanks to the conical tightening feature, it prevents the problems that may occur because of the size differences or ovality in pipes.
- + They prevent alga and bacteria forming due to UV proof (ultraviolet beam) structure.
- + O-rings are made of rubber and provide leakproofness under high pressure.
- + It has a homogeneous and non-porous inner surface.
- + It does not contain any harmful compounds which can change the taste or the smell of the water.
- + Female threaded products provide high leakproofness in changeable temperature values thanks to corrosion resistant reinforcing ring.
- + Thread sizes are compatible with ISO 7-1 Standard.
- + It is compatible with ISO 17885 Standard.



TS ISO 17885



**GARANTİ VERİLEN BASINÇ DEĞERİ**  
**GUARANTEED PRESSURE VALUE**  
**Ø 20 mm – Ø 110 mm: PN 16**

### KULLANIM ALANLARI

- + Şehir Şebekesi İçme Suyu
- + Peyzaj Sektörü
- + Tarımsal Sulama
- + Seralar

### INSTALLATION AREAS

- + Urban Potable Water Networks
- + Landscaping Systems
- + Agricultural Irrigation
- + Greenhouses

MAVİ SERİ GALVANİZ METAL YÜZÜKLÜ / BLUE SERIES WITH GALVANIZED REINFORCING RING

KOD CODE	EBAT/SIZE d x G	BASINÇ DEĞERİ PRESSURE VALUE PN	AMBALAJ ADEDİ PACKING QUANTITY	KOLİ ADEDİ BOX QUANTITY
10008111	20 x 1/2"	16	50	700
10008112	20 x 3/4"	16	50	550
10008121	25 x 1/2"	16	25	450
10008122	25 x 3/4"	16	25	450
10008123	25 x 1"	16	25	350
10008132	32 x 3/4"	16	25	275
10008133	32 x 1"	16	25	250
10008134	32 x 1 1/4"	16	25	200
10008143	40 x 1"	16	15	150
10008144	40 x 1 1/4"	16	15	150
10008145	40 x 1 1/2"	16	15	135
10008154	50 x 1 1/4"	16	10	90
10008155	50 x 1 1/2"	16	10	90
10008156	50 x 2"	16	10	80
10008165	63 x 1 1/2"	16	6	54
10008166	63 x 2"	16	6	48
10008167	63 x 2 1/2"	16	6	48
10008176	75 x 2"	16	4	32
10008177	75 x 2 1/2"	16	4	32
10008178	75 x 3"	16	4	28
10008186	90 x 2"	16	4	16
10008187	90 x 2 1/2"	16	4	16
10008188	90 x 3"	16	4	16
10008189	90 x 4"	16	4	12
10008195	110 x 2"	16	2	12
10008196	110 x 2 1/2"	16	2	12
10008197	110 x 3"	16	2	12
10008198	110 x 4"	16	2	12



**KABLİN DİŞİ**  
FEMALE ADAPTOR

**GALVANİZ METAL YÜZÜKLÜ**  
GALVANIZED REINFORCING RING

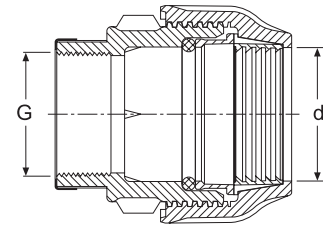

KOD CODE	EBAT/SIZE d x G x d	BASINÇ DEĞERİ PRESSURE VALUE PN	AMBALAJ ADEDİ PACKING QUANTITY	KOLİ ADEDİ BOX QUANTITY
10008311	20 x 1/2" x 20	16	15	270
10008312	20 x 3/4" x 20	16	15	240
10008321	25 x 1/2" x 25	16	10	200
10008322	25 x 3/4" x 25	16	10	180
10008323	25 x 1" x 25	16	10	160
10008331	32 x 1/2" x 32	16	10	120
10008332	32 x 3/4" x 32	16	10	110
10008333	32 x 1" x 32	16	10	100
10008334	32 x 1 1/4" x 32	16	10	100
10008342	40 x 3/4" x 40	16	5	60
10008343	40 x 1" x 40	16	5	60
10008344	40 x 1 1/4" x 40	16	5	55
10008345	40 x 1 1/2" x 40	16	5	50
10008352	50 x 3/4" x 50	16	4	40
10008353	50 x 1" x 50	16	4	40
10008354	50 x 1 1/4" x 50	16	4	40
10008355	50 x 1 1/2" x 50	16	4	40
10008356	50 x 2" x 50	16	4	32
10008363	63 x 1" x 63	16	3	24
10008364	63 x 1 1/4" x 63	16	3	21
10008365	63 x 1 1/2" x 63	16	3	21
10008366	63 x 2" x 63	16	3	21
10008367	63 x 2 1/2" x 63	16	3	18
10008376	75 x 2" x 75	16	1	14
10008377	75 x 2 1/2" x 75	16	1	12
10008378	75 x 3" x 75	16	1	12
10008387	90 x 2 1/2" x 90	16	1	8
10008388	90 x 3" x 90	16	1	6
10008389	90 x 4" x 90	16	1	7
10008396	110 x 2 1/2" x 110	16	1	6
10008397	110 x 3" x 110	16	1	5
10008398	110 x 4" x 110	16	1	4



**KABLİN DİŞİ TE**  
FEMALE TEE

**GALVANİZ METAL YÜZÜKLÜ**  
GALVANIZED REINFORCING RING

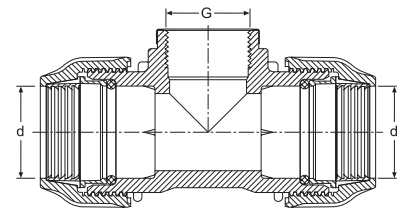



## KABLİN DIŞI DİRSEK

FEMALE ELBOW

**GALVANİZ METAL YÜZÜKLÜ**  
GALVANIZED REINFORCING RING

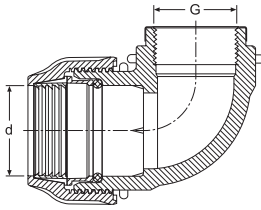

## KABLİN DUVAR DESTEKLİ DIŞI DİRSEK

WALL SUPPORTED FEMALE ELBOW

**GALVANİZ METAL YÜZÜKLÜ**  
GALVANIZED REINFORCING RING

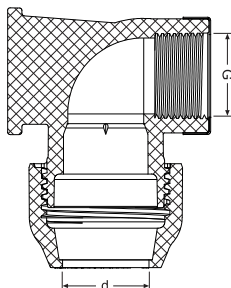

KOD CODE	EBAT/SIZE d x G	BASINÇ DEĞERİ PRESSURE VALUE PN	AMBALAJ ADEDİ PACKING QUANTITY	KOLİ ADEDİ BOX QUANTITY
10008511	20 x 1/2"	16	25	550
10008512	20 x 3/4"	16	25	450
10008521	25 x 1/2"	16	15	330
10008522	25 x 3/4"	16	15	330
10008523	25 x 1"	16	15	270
10008532	32 x 3/4"	16	10	220
10008533	32 x 1"	16	10	180
10008534	32 x 1 1/4"	16	10	150
10008543	40 x 1"	16	5	120
10008544	40 x 1 1/4"	16	5	100
10008545	40 x 1 1/2"	16	5	90
10008554	50 x 1 1/4"	16	4	72
10008555	50 x 1 1/2"	16	4	60
10008556	50 x 2"	16	4	52
10008565	63 x 1 1/2"	16	4	40
10008566	63 x 2"	16	4	40
10008567	63 x 2 1/2"	16	4	32
10008576	75 x 2"	16	2	24
10008577	75 x 2 1/2"	16	2	20
10008578	75 x 3"	16	2	18
10008587	90 x 2 1/2"	16	1	14
10008588	90 x 3"	16	1	13
10008589	90 x 4"	16	1	10
10008597	110 x 3"	16	1	8
10008598	110 x 4"	16	1	8

KOD CODE	EBAT/SIZE d x G	BASINÇ DEĞERİ PRESSURE VALUE PN	AMBALAJ ADEDİ PACKING QUANTITY	KOLİ ADEDİ BOX QUANTITY
10008711	20 x 1/2"	16	25	-
10008721	25 x 1/2"	16	15	-
10008722	25 x 3/4"	16	15	-
10008733	32 x 1"	16	10	-



KOD CODE	EBAT/SIZE d x G	BASINÇ DEĞERİ PRESSURE VALUE PN	AMBALAJ ADEDİ PACKING QUANTITY	KOLİ ADEDİ BOX QUANTITY
10007111	20 x 1/2"	16	50	700
10007112	20 x 3/4"	16	50	550
10007121	25 x 1/2"	16	25	450
10007122	25 x 3/4"	16	25	450
10007123	25 x 1"	16	25	350
10007132	32 x 3/4"	16	25	275
10007133	32 x 1"	16	25	250
10007134	32 x 1 1/4"	16	25	225
10007143	40 x 1"	16	15	150
10007144	40 x 1 1/4"	16	15	150
10007145	40 x 1 1/2"	16	15	135
10007154	50 x 1 1/4"	16	10	90
10007155	50 x 1 1/2"	16	10	90
10007156	50 x 2"	16	10	80
10007165	63 x 1 1/2"	16	6	54
10007166	63 x 2"	16	6	48
10007167	63 x 2 1/2"	16	6	48
10007176	75 x 2"	16	4	32
10007177	75 x 2 1/2"	16	4	32
10007178	75 x 3"	16	4	28
10007186	90 x 2"	16	4	16
10007187	90 x 2 1/2"	16	4	16
10007188	90 x 3"	16	4	16
10007189	90 x 4"	16	4	12
10007195	110 x 2"	16	2	12
10007196	110 x 2 1/2"	16	2	12
10007197	110 x 3"	16	2	12
10007198	110 x 4"	16	2	12

KOD CODE	EBAT/SIZE d x G x d	BASINÇ DEĞERİ PRESSURE VALUE PN	AMBALAJ ADEDİ PACKING QUANTITY	KOLİ ADEDİ BOX QUANTITY
10007311	20 x 1/2" x 20	16	15	270
10007312	20 x 3/4" x 20	16	15	240
10007321	25 x 1/2" x 25	16	10	200
10007322	25 x 3/4" x 25	16	10	180
10007323	25 x 1" x 25	16	10	160
10007331	32 x 1/2" x 32	16	10	120
10007332	32 x 3/4" x 32	16	10	110
10007333	32 x 1" x 32	16	10	100
10007334	32 x 1 1/4" x 32	16	10	100
10007342	40 x 3/4" x 40	16	5	60
10007343	40 x 1" x 40	16	5	60
10007344	40 x 1 1/4" x 40	16	5	55
10007345	40 x 1 1/2" x 40	16	5	50
10007352	50 x 3/4" x 50	16	4	40
10007353	50 x 1" x 50	16	4	40
10007354	50 x 1 1/4" x 50	16	4	40
10007355	50 x 1 1/2" x 50	16	4	40
10007356	50 x 2" x 50	16	4	32
10007363	63 x 1" x 63	16	3	21
10007364	63 x 1 1/4" x 63	16	3	21
10007365	63 x 1 1/2" x 63	16	3	21
10007366	63 x 2" x 63	16	3	21
10007367	63 x 2 1/2" x 63	16	3	18
10007376	75 x 2" x 75	16	1	14
10007377	75 x 2 1/2" x 75	16	1	12
10007378	75 x 3" x 75	16	1	12
10007387	90 x 2 1/2" x 90	16	1	8
10007388	90 x 3" x 90	16	1	6
10007389	90 x 4" x 90	16	1	7
10007396	110 x 2 1/2" x 110	16	1	6
10007397	110 x 3" x 110	16	1	5
10007398	110 x 4" x 110	16	1	4



## KABLİN DİŞİ FEMALE ADAPTOR

PASLANMAZ METAL YÜZÜKLÜ (AISI430)  
STAINLESS STEEL REINFORCING RING

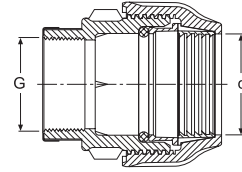

## KABLİN DİŞİ TE FEMALE TEE

PASLANMAZ METAL YÜZÜKLÜ (AISI430)  
STAINLESS STEEL REINFORCING RING

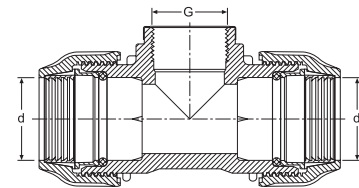



## KABLİN DIŞI DİRSEK

FEMALE ELBOW

PASLANMAZ METAL YÜZÜKLÜ (AISI430)  
STAINLESS STEEL REINFORCING RING

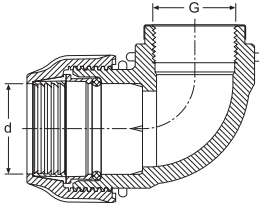

## KABLİN DUVAR DESTEKLİ DIŞI DİRSEK

WALL SUPPORTED FEMALE ELBOW

PASLANMAZ METAL YÜZÜKLÜ (AISI430)  
STAINLESS STEEL REINFORCING RING

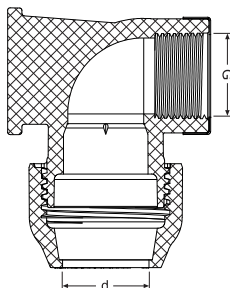

KOD CODE	EBAT/SIZE d x G	BASINÇ DEĞERİ PRESSURE VALUE PN	AMBALAJ ADEDİ PACKING QUANTITY	KOLİ ADEDİ BOX QUANTITY
10007511	20 x 1/2"	16	25	550
10007512	20 x 3/4"	16	25	450
10007521	25 x 1/2"	16	15	360
10007522	25 x 3/4"	16	15	330
10007523	25 x 1"	16	15	270
10007532	32 x 3/4"	16	10	220
10007533	32 x 1"	16	10	180
10007534	32 x 1 1/4"	16	10	150
10007543	40 x 1"	16	5	120
10007544	40 x 1 1/4"	16	5	100
10007545	40 x 1 1/2"	16	5	90
10007554	50 x 1 1/4"	16	4	72
10007555	50 x 1 1/2"	16	4	60
10007556	50 x 2"	16	4	52
10007565	63 x 1 1/2"	16	4	40
10007566	63 x 2"	16	4	40
10007567	63 x 2 1/2"	16	4	32
10007576	75 x 2"	16	2	24
10007577	75 x 2 1/2"	16	2	20
10007578	75 x 3"	16	2	18
10007587	90 x 2 1/2"	16	1	14
10007588	90 x 3"	16	1	13
10007589	90 x 4"	16	1	10
10007597	110 x 3"	16	1	8
10007598	110 x 4"	16	1	8

KOD CODE	EBAT/SIZE d x G	BASINÇ DEĞERİ PRESSURE VALUE PN	AMBALAJ ADEDİ PACKING QUANTITY	KOLİ ADEDİ BOX QUANTITY
10007711	20 x 1/2"	16	25	-
10007721	25 x 1/2"	16	15	-
10007722	25 x 3/4"	16	15	-
10007733	32 x 1"	16	10	-

# MAVİ SERİ / BLUE SERIES COMPRESSION FITTINGS

KOD CODE	EBAT / SIZE d x G	BASINÇ DEĞERİ PRESSURE VALUE PN	AMBALAJ ADEDİ PACKING QUANTITY	KOLİ ADEDİ BOX QUANTITY
10001011	20 x 1/2"	16	50	800
10001012	20 x 3/4"	16	50	700
10001021	25 x 1/2"	16	25	550
10001022	25 x 3/4"	16	25	500
10001023	25 x 1"	16	25	450
10001031	32 x 1/2"	16	25	300
10001032	32 x 3/4"	16	25	300
10001033	32 x 1"	16	25	275
10001034	32 x 1 1/4"	16	25	250
10001043	40 x 1"	16	15	150
10001044	40 x 1 1/4"	16	15	150
10001045	40 x 1 1/2"	16	15	150
10001054	50 x 1 1/4"	16	10	90
10001055	50 x 1 1/2"	16	10	90
10001056	50 x 2"	16	10	90
10001065	63 x 1 1/2"	16	6	60
10001066	63 x 2"	16	6	54
10001067	63 x 2 1/2"	16	6	54
10001076	75 x 2"	16	4	32
10001077	75 x 2 1/2"	16	4	32
10001078	75 x 3"	16	4	32
10001086	90 x 2"	16	4	20
10001087	90 x 2 1/2"	16	4	16
10001088	90 x 3"	16	4	16
10001089	90 x 4"	16	4	16
10001095	110 x 2"	16	2	12
10001096	110 x 2 1/2"	16	2	12
10001097	110 x 3"	16	2	12
10001098	110 x 4"	16	2	12



**KABLİN ERKEK**  
MALE ADAPTOR

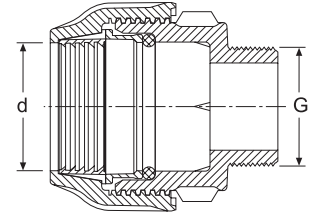

**KABLİN MANŞON**  
COUPLING

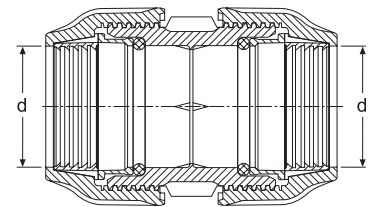

KOD CODE	EBAT / SIZE d x d	BASINÇ DEĞERİ PRESSURE VALUE PN	AMBALAJ ADEDİ PACKING QUANTITY	KOLİ ADEDİ BOX QUANTITY
10002011	20 x 20	16	25	425
10002022	25 x 25	16	25	300
10002033	32 x 32	16	10	170
10002044	40 x 40	16	10	90
10002055	50 x 50	16	6	60
10002066	63 x 63	16	5	35
10002077	75 x 75	16	2	18
10002088	90 x 90	16	2	10
10002099	110 x 110	16	1	8



# MAVİ SERİ / BLUE SERIES COMPRESSION FITTINGS



**KABLİN TE**  
TEE

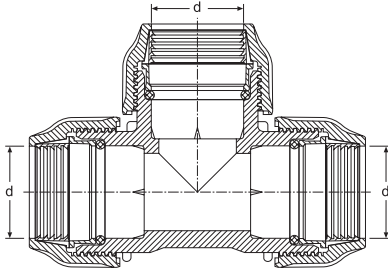

KOD CODE	EBAT / SIZE d x d x d	BASINÇ DEĞERİ PRESSURE VALUE PN	AMBALAJ ADEDİ PACKING QUANTITY	KOLİ ADEDİ BOX QUANTITY
10002500	16 x 16 x 16	16	15	440
10002511	20 x 20 x 20	16	15	240
10002522	25 x 25 x 25	16	10	150
10002533	32 x 32 x 32	16	5	80
10002544	40 x 40 x 40	16	5	50
10002555	50 x 50 x 50	16	4	32
10002566	63 x 63 x 63	16	3	18
10002577	75 x 75 x 75	16	1	10
10002588	90 x 90 x 90	16	1	5
10002599	110 x 110 x 110	16	1	3



**KABLİN ERKEK TE**  
MALE TEE

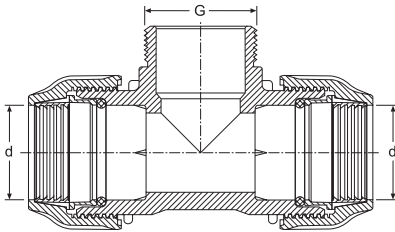

KOD CODE	EBAT / SIZE d x G x d	BASINÇ DEĞERİ PRESSURE VALUE PN	AMBALAJ ADEDİ PACKING QUANTITY	KOLİ ADEDİ BOX QUANTITY
10003011	20 x 1/2" x 20	16	15	300
10003012	20 x 3/4" x 20	16	15	300
10003021	25 x 1/2" x 25	16	10	200
10003022	25 x 3/4" x 25	16	10	200
10003023	25 x 1" x 25	16	10	180
10003032	32 x 3/4" x 32	16	10	120
10003033	32 x 1" x 32	16	10	110
10003034	32 x 1 1/4" x 32	16	10	100
10003043	40 x 1" x 40	16	5	70
10003044	40 x 1 1/4" x 40	16	5	60
10003045	40 x 1 1/2" x 40	16	5	55
10003053	50 x 1" x 50	16	4	44
10003054	50 x 1 1/4" x 50	16	4	44
10003055	50 x 1 1/2" x 50	16	4	40
10003056	50 x 2" x 50	16	4	32
10003064	63 x 1 1/4" x 63	16	3	27
10003065	63 x 1 1/2" x 63	16	3	24
10003066	63 x 2" x 63	16	3	21
10003067	63 x 2 1/2" x 63	16	3	18
10003076	75 x 2" x 75	16	1	16
10003077	75 x 2 1/2" x 75	16	1	14
10003078	75 x 3" x 75	16	1	12
10003086	90 x 2" x 90	16	1	9
10003087	90 x 2 1/2" x 90	16	1	8
10003088	90 x 3" x 90	16	1	8
10003089	90 x 4" x 90	16	1	6
10003096	110 x 2 1/2" x 110	16	1	6
10003097	110 x 3" x 110	16	1	5
10003098	110 x 4" x 110	16	1	5

## MAVİ SERİ / BLUE SERIES COMPRESSION FITTINGS

KOD CODE	EBAT / SIZE d x d	BASINÇ DEĞERİ PRESSURE VALUE PN	AMBALAJ ADEDİ PACKING QUANTITY	KOLİ ADEDİ BOX QUANTITY
10004011	20 x 20	16	25	400
10004022	25 x 25	16	15	240
10004033	32 x 32	16	10	140
10004044	40 x 40	16	5	75
10004055	50 x 50	16	4	44
10004066	63 x 63	16	4	28
10004077	75 x 75	16	2	16
10004088	90 x 90	16	1	8
10004099	110 x 110	16	1	5



**KABLİN DİRSEK**  
ELBOW

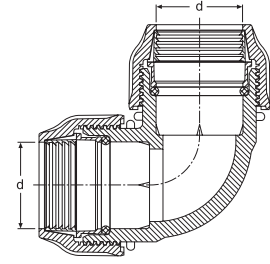

KOD CODE	EBAT / SIZE d x G	BASINÇ DEĞERİ PRESSURE VALUE PN	AMBALAJ ADEDİ PACKING QUANTITY	KOLİ ADEDİ BOX QUANTITY
10004511	20 x 1/2"	16	25	600
10004512	20 x 3/4"	16	25	550
10004521	25 x 1/2"	16	15	390
10004522	25 x 3/4"	16	15	390
10004523	25 x 1"	16	15	330
10004532	32 x 3/4"	16	10	240
10004533	32 x 1"	16	10	220
10004534	32 x 1 1/4"	16	10	180
10004543	40 x 1"	16	5	120
10004544	40 x 1 1/4"	16	5	120
10004545	40 x 1 1/2"	16	5	110
10004554	50 x 1 1/4"	16	4	72
10004555	50 x 1 1/2"	16	4	72
10004556	50 x 2"	16	4	64
10004565	63 x 1 1/2"	16	4	44
10004566	63 x 2"	16	4	40
10004567	63 x 2 1/2"	16	4	36
10004576	75 x 2"	16	2	24
10004577	75 x 2 1/2"	16	2	24
10004578	75 x 3"	16	2	20
10004587	90 x 2 1/2"	16	1	14
10004588	90 x 3"	16	1	14
10004589	90 x 4"	16	1	12
10004597	110 x 3"	16	1	8
10004598	110 x 4"	16	1	8



**KABLİN ERKEK  
DİRSEK**  
MALE ELBOW

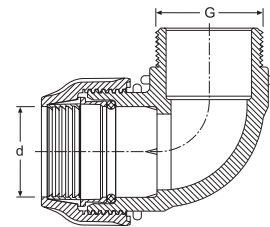



## KABLİN REDÜKSİYON TE REDUCING TEE

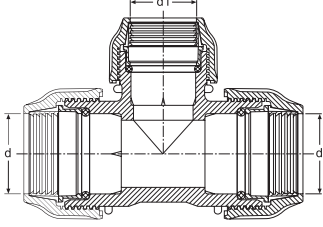

KOD CODE	EBAT / SIZE d x d, x d	BASINÇ DEĞERİ PRESSURE VALUE PN	AMBALAJ ADEDİ PACKING QUANTITY	KOLİ ADEDİ BOX QUANTITY
10005521	25 x 20 x 25	16	10	180
10005531	32 x 20 x 32	16	5	120
10005532	32 x 25 x 32	16	5	100
10005542	40 x 25 x 40	16	5	65
10005543	40 x 32 x 40	16	5	55
10005552	50 x 25 x 50	16	4	40
10005553	50 x 32 x 50	16	4	40
10005554	50 x 40 x 50	16	4	40
10005562	63 x 25 x 63	16	3	24
10005563	63 x 32 x 63	16	3	24
10005564	63 x 40 x 63	16	3	21
10005565	63 x 50 x 63	16	3	21
10005575	75 x 50 x 75	16	1	14
10005576	75 x 63 x 75	16	1	12
10005586	90 x 63 x 90	16	1	8
10005587	90 x 75 x 90	16	1	7
10005596	110 x 63 x 110	16	1	6
10005597	110 x 75 x 110	16	1	4
10005598	110 x 90 x 110	16	1	4



## KABLİN REDÜKSİYON MANŞON REDUCING COUPLING

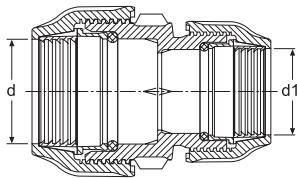

KOD CODE	EBAT / SIZE d x d <sub>1</sub>	BASINÇ DEĞERİ PRESSURE VALUE PN	AMBALAJ ADEDİ PACKING QUANTITY	KOLİ ADEDİ BOX QUANTITY
10006021	25 x 20	16	25	350
10006031	32 x 20	16	10	240
10006032	32 x 25	16	10	200
10006041	40 x 20	16	10	150
10006042	40 x 25	16	10	140
10006043	40 x 32	16	10	120
10006052	50 x 25	16	6	90
10006053	50 x 32	16	6	84
10006054	50 x 40	16	6	72
10006062	63 x 25	16	6	54
10006063	63 x 32	16	6	48
10006064	63 x 40	16	6	48
10006065	63 x 50	16	6	36
10006075	75 x 50	16	2	28
10006076	75 x 63	16	2	24
10006086	90 x 63	16	2	14
10006087	90 x 75	16	2	12
10006096	110 x 63	16	1	10
10006097	110 x 75	16	1	8
10006098	110 x 90	16	1	8

## MAVİ SERİ / BLUE SERIES COMPRESSION FITTINGS

KOD CODE	EBAT / SIZE d x d <sub>1</sub>	BASINÇ DEĞERİ PRESSURE VALUE PN	AMBALAJ ADEDİ PACKING QUANTITY	KOLİ ADEDİ BOX QUANTITY
10006521	25 x 20	16	15	270
10006532	32 x 25	16	10	180
10006543	40 x 32	16	5	90
10006554	50 x 40	16	4	52
10006565	63 x 50	16	4	32
10006576	75 x 63	16	2	18
10006587	90 x 75	16	1	11
10006598	110 x 90	16	1	6



### KABLİN REDÜKSİYON DİRSEK

REDUCING ELBOW

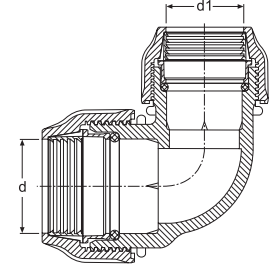

KOD CODE	EBAT / SIZE d	BASINÇ DEĞERİ PRESSURE VALUE PN	AMBALAJ ADEDİ PACKING QUANTITY	KOLİ ADEDİ BOX QUANTITY
10007011	20	16	50	800
10007022	25	16	25	500
10007033	32	16	25	300
10007044	40	16	15	165
10007055	50	16	12	96
10007066	63	16	6	60
10007077	75	16	4	32
10007088	90	16	4	16
10007099	110	16	2	12



### KABLİN KÖR TAPA

END CAP

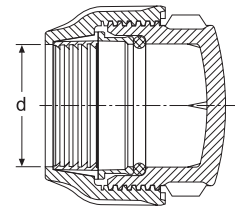



# MAVİ SERİ / BLUE SERIES COMPRESSION FITTINGS



**TAMİR MANŞONU**  
REPAIRING COUPLING

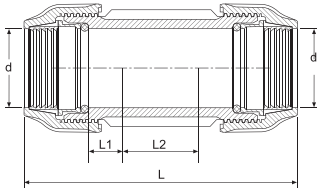

KOD CODE	EBAT SIZE	BASINÇ DEĞERİ PRESSURE VALUE PN	AMBALAJ ADEDİ PACKING QUANTITY	KOLİ ADEDİ BOX QUANTITY	L	L <sub>1</sub>	L <sub>2</sub>
10009011	20	16	25	350	100	14.5	25
10009022	25	16	25	225	115	14.5	30
10009033	32	16	10	120	140	16.0	40
10009044	40	16	10	70	168	19.0	50
10009055	50	16	6	36	183	21.5	60
10009066	63	16	4	24	225	25.0	70
10009077	75	16	2	14	260	30.0	80
10009088	90	16	2	8	310	35.5	100
10009099	110	16	1	5	355	41.0	115



**FLANŞLI ADAPTÖR**  
FLANGED ADAPTOR

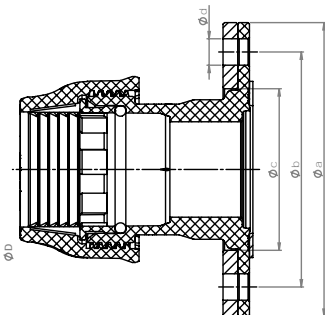

KOD CODE	EBAT / SIZE D	BASINÇ DEĞERİ PRESSURE VALUE PN	AMBALAJ ADEDİ PACKING QUANTITY	KOLİ ADEDİ BOX QUANTITY	a	b	c	d
10002156	50x2"	16	1	19	165	125	80	18
10002166	63x2"	16	1	18	165	125	92	18
10002177	75x2 1/2"	16	1	13	185	145	110	18
10002178	75x3"	16	1	12	200	160	110	18
10002188	90x3"	16	1	10	200	160	125	18
10002189	90x4"	16	1	9	220	180	125	18
10002199	110x4"	16	1	8	220	180	144	18



**KABLİN ANAHTARI**  
FITTING SPANNER

**MAVİ SERİ KABLİN ANAHTAR**  
(Blue Series Fitting Spanner)

KOD CODE	EBAT SIZE	AMBALAJ ADEDİ PACKING QUANTITY	KOLİ ADEDİ BOX QUANTITY
10009511	20	5	600
10009522	25	5	500
10009533	32	5	400
10009544	40	5	300
10009555	50	5	230
10009566	63	5	180
10009577	75	5	110
10009588	90	5	75
10009599	110	5	50



**GARANTİ VERİLEN BASINÇ DEĞERİ**  
GUARANTEED PRESSURE VALUE  
Ø 125 mm: PN 10

KOD CODE	EBAT/SIZE d x G	ÜRÜN PRODUCT	BASINÇ DEĞERİ PRESSURE VALUE PN	AMBALAJ ADEDİ PACKING QUANTITY	KOLİ ADEDİ BOX QUANTITY
109919	125 x 4"	KABLİN ERKEK / MALE ADAPTOR	10	2	8
109910	125 x 5"	KABLİN ERKEK / MALE ADAPTOR	10	2	8
159910	125 x 5"	KABLİN DIŞI / FEMALE ADAPTOR	10	2	6
209999	125 x 125	KABLİN MANŞON / COUPLING	10	1	4
259999	125 x 125 x 125	KABLİN TE / TEE	10	1	2
309909	125 x 4" x 125	KABLİN ERKEK TE / MALE TEE	10	1	2
309910	125 x 5" x 125	KABLİN ERKEK TE / MALE TEE	10	1	2
359910	125 x 5" x 125	KABLİN DIŞI TE / FEMALE TEE	10	1	2
409999	125 x 125	KABLİN DİRSEK / ELBOW	10	1	4
459910	125 x 5"	KABLİN ERKEK DİRSEK / MALE ELBOW	10	1	5
509910	125 x 5"	KABLİN DIŞI DİRSEK / FEMALE ELBOW	10	1	4
559909	125 x 110 x 125	KABLİN REDÜKSİYON TE / REDUCING TEE	10	1	2
609909	125 x 110	KABLİN REDÜKSİYON MANŞON / REDUCING COUPLING	10	1	5
659999	125	KABLİN KÖR TAPA / END CAP	10	2	8
49699	125 - 6"	KABLİN SIKMA ANAHTARI / FITTING SPANNER		2	24

# ISO 17885 STANDARDI - TESTLER

## ISO 17885 STANDARD - TESTS

**PLASTİK MALZEMENİN UZUN VADEDE DAVRANIŞININ DOĞRULANMASI**  
*Ekleme parçalarının gövdeleri, ISO 1167-1 test standardına göre test edilmektedir.*

**VERIFICATION OF LONG-TERM BEHAVIOUR OF THE PLASTIC MATERIAL**  
*Compression fittings bodies are tested according to the ISO 1167-1 test standard.*

MALZEME MATERIAL	TEST SICAKLIĞI / °C TEST TEMPERATURE	TEST SÜRESİ / SAAT TEST DURATION / HOUR	TEST BASINCI / BAR TEST PRESSURE PN 16
PP-B	20	1	40.6
	95	1.000	6.6
PP-H	20	1	53.3
	95	1.000	9.1

### İÇ BASINÇ ALTINDA UZUN SÜRELİ SIZDIRMAZLIK

*Montajlanmış ekleme parçaları, ISO 3458, ISO 1167-1, ISO 1167-4 test standardına göre test edilmektedir.*

#### LONG-TERM LEAKPROOFNESS UNDER INTERNAL PRESSURE

*Assembled fittings are tested according to the ISO 3458, ISO 1167-1, ISO 1167-4 test standard.*

TEST SICAKLIĞI / °C TEST TEMPERATURE	TEST SÜRESİ / SAAT TEST DURATION / HOUR	TEST BASINCI / BAR TEST PRESSURE PN 16
20	1.000	19.2



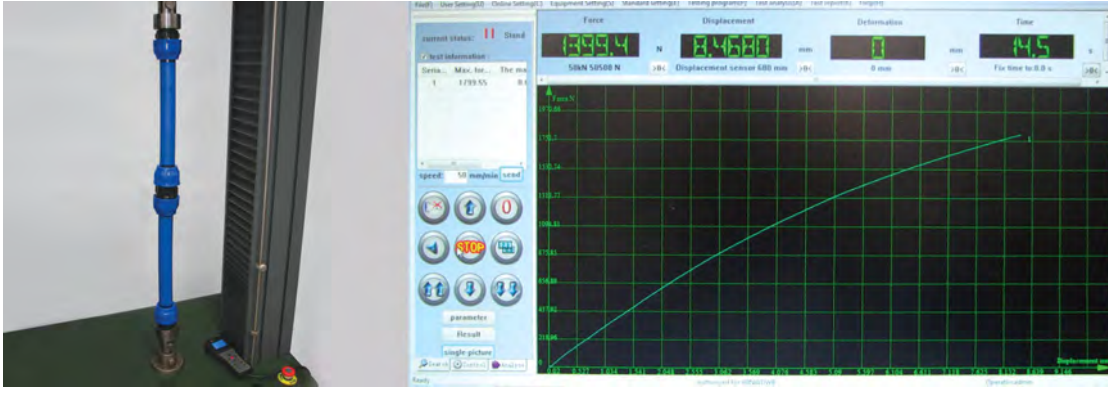

### 23 °C SICAKLIKTA AYRILMA DİRENCİ

PE boru ile montajlanmış ekleme parçaları, ISO 3501 test standardına göre test edilmektedir.

### RESISTANCE TO PULL-OUT AT 23 °C

Compression fittings, assembled with PE pipes, are tested according to the ISO 3501 test standard.

PN 16 Grubu için Çekme Kuvveti (Newton) Pull Force for PN 16 Group (Newton)

Ø20	Ø25	Ø32	Ø40	Ø50	Ø63	Ø75	Ø90	Ø110
1.119	1.686	2.704	4.175	6.492	10.313	14.416	20.086	31.086

### İÇ BASINÇ ALTINDA SIZDIRMAZLIK

Montajlanmış ekleme parçaları, ISO 3458 test standardına göre test edilmektedir.

### LEAKPROOFNESS UNDER INTERNAL PRESSURE

Assembled fittings are tested according to the ISO 3458 test standard.

TEST SICAKLIĞI / °C  
TEST TEMPERATURE

20 ± 5

TEST SÜRESİ / SAAT  
TEST DURATION / HOUR

1

TEST BASINCI / BAR  
TEST PRESSURE  
PN 16

24,0

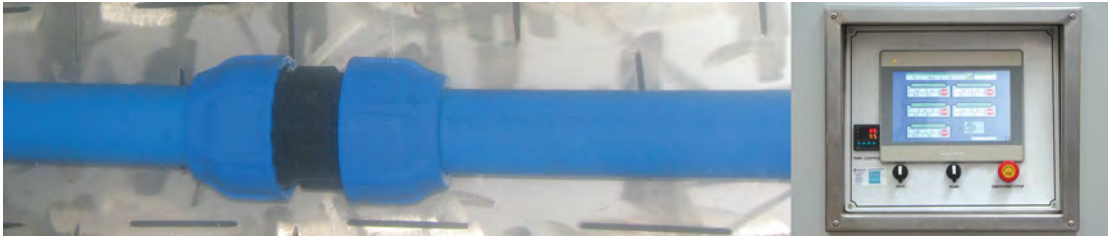

### BÜKÜLÜ İKEN İÇ BASINÇ ALTINDA SIZDIRMAZLIK

Montajlanmış ekleme parçaları, ISO 3503 test standardına göre test edilmektedir.

### LEAKPROOFNESS UNDER INTERNAL PRESSURE WHEN SUBJECTED TO BENDING

Assembled fittings are tested according to the ISO 3503 test standard.

TEST SICAKLIĞI / °C  
TEST TEMPERATURE

23 ± 2

TEST SÜRESİ / SAAT  
TEST DURATION / HOUR

1

TEST BASINCI / BAR  
TEST PRESSURE  
PN 16

24,0

**DİŞLER** Ekleme parçaları için dişler, ISO 7-1 standardına uygundur.

**THREADS** Threads for compression fittings are covered by ISO 7-1 standard.

**SU KALİTESİ ÜZERİNDEKİ ETKİSİ** Ekleme parçaları, içme suyu üzerinde mikroorganizmaların çoğalmalarına izin vermemelidir. KIWA ve TSE kuruluşlarının laboratuvarları tarafından ilgili testler yapılarak raporlandırılmıştır.

**INFLUENCE ON WATER QUALITY** Compression fittings must not allow increasing microorganism on drinking water. It is reported with the related tests by the laboratories of KIWA and TSE Institutions.



## Özellikler

- + Darbelere karşı dayanıklı, yüksek kaliteli polipropilen hammaddeden üretilmiştir.
- + Borulardaki ölçü farklılıklarından veya ovalikten oluşabilecek sorunları konik sıkma özelliği sayesinde önler.
- + UV ışınlarını geçirmediği için yosunlanmaya ve bakteri üremesine izin vermez.
- + Oringi kauçuktan üretilmekte olup yüksek basınç altında sızdırmazlık sağlar.
- + İç yüzeyleri homojen ve gözeneksizdir.
- + Suyun kokusunu ve tadını değiştirebilecek zararlı bileşikler içermez.
- + Dişi ürünlerimiz, korozyona dayanıklı metal yüzük sayesinde değişken sıcaklıklarda yüksek sızdırmazlık sağlar.
- + Diş ölçüleri ISO 7-1 Standardına uygundur.
- + ISO 17885 Standardına uygundur.

## Specifications

- + It has been produced from high quality polypropylene raw material and it has resistance to impact.
- + Thanks to the conical tightening feature, it prevents the problems that may occur because of the size differences or ovality in pipes.
- + They prevent alga and bacteria forming due to UV proof (ultraviolet beam) structure.
- + O-rings are made of rubber and provide leakproofness under high pressure.
- + It has a homogeneous and non-porous inner surface.
- + It does not contain any harmful compounds which can change the taste or the smell of the water.
- + Female threaded products provide high leakproofness in changeable temperature values thanks to corrosion resistant reinforcing ring.
- + Thread sizes are compatible with ISO 7-1 Standard.
- + It is compatible with ISO 17885 Standard.



TS ISO 17885

**GARANTİ VERİLEN BASINÇ DEĞERİ**  
**GUARANTEED PRESSURE VALUE**  
Ø 20 mm – Ø 63 mm : PN 10  
Ø 75 mm – Ø 110 mm: PN 6

### KULLANIM ALANLARI

- + Peyzaj Sektörü
- + Tarımsal Sulama
- + Seralar

### INSTALLATION AREAS

- + Landscaping Systems
- + Agricultural Irrigation
- + Greenhouses

KOD CODE	EBAT / SIZE d x G	BASINÇ DEĞERİ PRESSURE VALUE PN	AMBALAJ ADEDİ PACKING QUANTITY	KOLİ ADEDİ BOX QUANTITY
YS7211	20 x 1/2"	10	50	650
YS7212	20 x 3/4"	10	50	600
YS7221	25 x 1/2"	10	25	450
YS7222	25 x 3/4"	10	25	425
YS7223	25 x 1"	10	25	350
YS7231	32 x 1/2"	10	25	325
YS7232	32 x 3/4"	10	25	300
YS7233	32 x 1"	10	25	250
YS7234	32 x 1 1/4"	10	25	200
YS7243	40 x 1"	10	15	150
YS7244	40 x 1 1/4"	10	15	150
YS7245	40 x 1 1/2"	10	15	135
YS7246	40 x 2"	10	15	120
YS7254	50 x 1 1/4"	10	10	100
YS7255	50 x 1 1/2"	10	10	100
YS7256	50 x 2"	10	10	80
YS7265	63 x 1 1/2"	10	6	66
YS7266	63 x 2"	10	6	60
YS7267	63 x 2 1/2"	10	6	54
YS7276	75 x 2"	6	4	36
YS7277	75 x 2 1/2"	6	4	32
YS7278	75 x 3"	6	4	28
YS7286	90 x 2"	6	4	24
YS7287	90 x 2 1/2"	6	4	20
YS7288	90 x 3"	6	4	20
YS7289	90 x 4"	6	4	20
YS7298	110 x 3"	6	2	14
YS7299	110 x 4"	6	2	12

KOD CODE	EBAT / SIZE d x G x d	BASINÇ DEĞERİ PRESSURE VALUE PN	AMBALAJ ADEDİ PACKING QUANTITY	KOLİ ADEDİ BOX QUANTITY
YS7811	20 x 1/2" x 20	10	15	270
YS7812	20 x 3/4" x 20	10	15	270
YS7821	25 x 1/2" x 25	10	10	200
YS7822	25 x 3/4" x 25	10	10	180
YS7823	25 x 1" x 25	10	10	180
YS7831	32 x 1/2" x 32	10	10	140
YS7832	32 x 3/4" x 32	10	10	130
YS7833	32 x 1" x 32	10	10	120
YS7834	32 x 1 1/4" x 32	10	10	100
YS7842	40 x 3/4" x 40	10	5	70
YS7843	40 x 1" x 40	10	5	70
YS7844	40 x 1 1/4" x 40	10	5	60
YS7845	40 x 1 1/2" x 40	10	5	55
YS7852	50 x 3/4" x 50	10	4	48
YS7853	50 x 1" x 50	10	4	48
YS7854	50 x 1 1/4" x 50	10	4	44
YS7855	50 x 1 1/2" x 50	10	4	44
YS7856	50 x 2" x 50	10	4	36
YS7863	63 x 1" x 63	10	3	30
YS7864	63 x 1 1/4" x 63	10	3	27
YS7865	63 x 1 1/2" x 63	10	3	27
YS7866	63 x 2" x 63	10	3	27
YS7867	63 x 2 1/2" x 63	10	3	24
YS7876	75 x 2" x 75	6	1	18
YS7877	75 x 2 1/2" x 75	6	1	15
YS7878	75 x 3" x 75	6	1	12
YS7887	90 x 2 1/2" x 90	6	1	10
YS7888	90 x 3" x 90	6	1	10
YS7889	90 x 4" x 90	6	1	9
YS7898	110 x 3" x 110	6	1	6
YS7899	110 x 4" x 110	6	1	5



**KABLİN DİŞİ**  
FEMALE ADAPTOR

**GALVANİZ METAL YÜZÜKLÜ**  
GALVANIZED REINFORCING RING

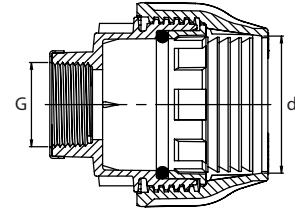

**KABLİN DİŞİ TE**  
FEMALE TEE

**GALVANİZ METAL YÜZÜKLÜ**  
GALVANIZED REINFORCING RING

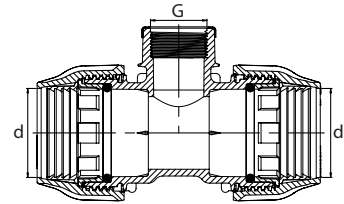



## KABLİN DIŞI DİRSEK

FEMALE ELBOW

**GALVANİZ METAL YÜZÜKLÜ**  
GALVANIZED REINFORCING RING

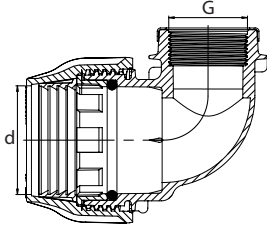

KOD CODE	EBAT / SIZE d x G	BASINÇ DEĞERİ PRESSURE VALUE PN	AMBALAJ ADEDİ PACKING QUANTITY	KOLİ ADEDİ BOX QUANTITY
YS8311	20 x 1/2"	10	25	500
YS8312	20 x 3/4"	10	25	500
YS8321	25 x 1/2"	10	15	375
YS8322	25 x 3/4"	10	15	345
YS8323	25 x 1"	10	15	300
YS8331	32 x 1/2"	10	10	250
YS8332	32 x 3/4"	10	10	240
YS8333	32 x 1"	10	10	200
YS8334	32 x 1 1/4"	10	10	170
YS8343	40 x 1"	10	5	120
YS8344	40 x 1 1/4"	10	5	100
YS8345	40 x 1 1/2"	10	5	100
YS8354	50 x 1 1/4"	10	4	76
YS8355	50 x 1 1/2"	10	4	72
YS8356	50 x 2"	10	4	60
YS8365	63 x 1 1/2"	10	4	52
YS8366	63 x 2"	10	4	48
YS8367	63 x 2 1/2"	10	4	36
YS8376	75 x 2"	6	2	28
YS8377	75 x 2 1/2"	6	2	24
YS8378	75 x 3"	6	2	22
YS8387	90 x 2 1/2"	6	1	18
YS8388	90 x 3"	6	1	17
YS8389	90 x 4"	6	1	13
YS8398	110 x 3"	6	1	10
YS8399	110 x 4"	6	1	9

# YEŞİL SERİ / GREEN SERIES COMPRESSION FITTINGS

KOD CODE	EBAT / SIZE d x G	BASINÇ DEĞERİ PRESSURE VALUE PN	AMBALAJ ADEDİ PACKING QUANTITY	KOLİ ADEDİ BOX QUANTITY
YS7111	20 x 1/2"	10	50	800
YS7112	20 x 3/4"	10	50	750
YS7121	25 x 1/2"	10	25	550
YS7122	25 x 3/4"	10	25	500
YS7123	25 x 1"	10	25	450
YS7131	32 x 1/2"	10	25	350
YS7132	32 x 3/4"	10	25	325
YS7133	32 x 1"	10	25	300
YS7134	32 x 1 1/4"	10	25	300
YS7143	40 x 1"	10	15	180
YS7144	40 x 1 1/4"	10	15	165
YS7145	40 x 1 1/2"	10	15	165
YS7153	50 x 1"	10	10	110
YS7154	50 x 1 1/4"	10	10	110
YS7155	50 x 1 1/2"	10	10	100
YS7156	50 x 2"	10	10	90
YS7165	63 x 1 1/2"	10	6	72
YS7166	63 x 2"	10	6	66
YS7167	63 x 2 1/2"	10	6	60
YS7176	75 x 2"	6	4	36
YS7177	75 x 2 1/2"	6	4	32
YS7178	75 x 3"	6	4	32
YS7186	90 x 2"	6	4	24
YS7187	90 x 2 1/2"	6	4	24
YS7188	90 x 3"	6	4	24
YS7189	90 x 4"	6	4	20
YS7198	110 x 3"	6	2	14
YS7199	110 x 4"	6	2	12

KOD CODE	EBAT / SIZE d x d	BASINÇ DEĞERİ PRESSURE VALUE PN	AMBALAJ ADEDİ PACKING QUANTITY	KOLİ ADEDİ BOX QUANTITY
YS7311	20 x 20	10	25	400
YS7322	25 x 25	10	25	275
YS7333	32 x 32	10	10	180
YS7344	40 x 40	10	10	100
YS7355	50 x 50	10	6	66
YS7366	63 x 63	10	5	40
YS7377	75 x 75	6	2	18
YS7388	90 x 90	6	2	14
YS7399	110 x 110	6	1	8



**KABLİN ERKEK**  
MALE ADAPTOR

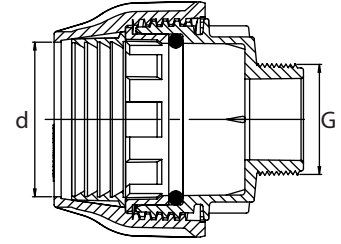

**KABLİN MANŞON**  
COUPLING

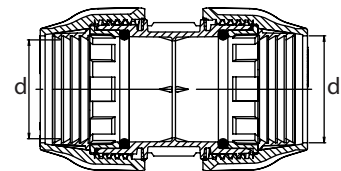



# YEŞİL SERİ / GREEN SERIES COMPRESSION FITTINGS



**KABLİN TE**  
TEE

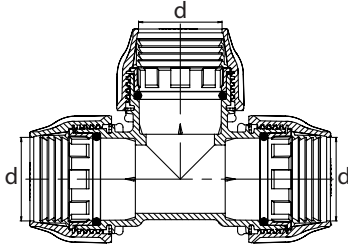

KOD CODE	EBAT / SIZE d x d x d	BASINÇ DEĞERİ PRESSURE VALUE PN	AMBALAJ ADEDİ PACKING QUANTITY	KOLİ ADEDİ BOX QUANTITY
YS7611	20 x 20 x 20	10	15	240
YS7622	25 x 25 x 25	10	10	150
YS7633	32 x 32 x 32	10	5	100
YS7644	40 x 40 x 40	10	5	50
YS7655	50 x 50 x 50	10	4	36
YS7666	63 x 63 x 63	10	3	24
YS7677	75 x 75 x 75	6	1	11
YS7688	90 x 90 x 90	6	1	8
YS7699	110 x 110 x 110	6	1	4



**KABLİN ERKEK TE**  
MALE TEE

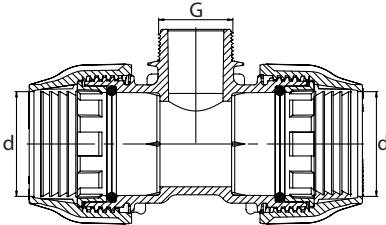

KOD CODE	EBAT / SIZE d x G x d	BASINÇ DEĞERİ PRESSURE VALUE PN	AMBALAJ ADEDİ PACKING QUANTITY	KOLİ ADEDİ BOX QUANTITY
YS7711	20 x 1/2" x 20	10	15	300
YS7712	20 x 3/4" x 20	10	15	300
YS7721	25 x 1/2" x 25	10	10	210
YS7722	25 x 3/4" x 25	10	10	200
YS7723	25 x 1" x 25	10	10	200
YS7724	25 x 1 1/4" x 25	10	10	140
YS7731	32 x 1/2" x 32	10	10	140
YS7732	32 x 3/4" x 32	10	10	140
YS7733	32 x 1" x 32	10	10	130
YS7734	32 x 1 1/4" x 32	10	10	120
YS7743	40 x 1" x 40	10	5	70
YS7744	40 x 1 1/4" x 40	10	5	70
YS7745	40 x 1 1/2" x 40	10	5	60
YS7753	50 x 1" x 50	10	4	48
YS7754	50 x 1 1/4" x 50	10	4	48
YS7755	50 x 1 1/2" x 50	10	4	44
YS7756	50 x 2" x 50	10	4	36
YS7764	63 x 1 1/4" x 63	10	3	30
YS7765	63 x 1 1/2" x 63	10	3	30
YS7766	63 x 2" x 63	10	3	27
YS7767	63 x 2 1/2" x 63	10	3	24
YS7776	75 x 2" x 75	6	1	18
YS7777	75 x 2 1/2" x 75	6	1	16
YS7778	75 x 3" x 75	6	1	13
YS7787	90 x 2 1/2" x 90	6	1	10
YS7788	90 x 3" x 90	6	1	9
YS7789	90 x 4" x 90	6	1	9
YS7798	110 x 3" x 110	6	1	6
YS7799	110 x 4" x 110	6	1	7

# YEŞİL SERİ / GREEN SERIES COMPRESSION FITTINGS

KOD CODE	EBAT / SIZE d x d	BASINÇ DEĞERİ PRESSURE VALUE PN	AMBALAJ ADEDİ PACKING QUANTITY	KOLİ ADEDİ BOX QUANTITY
YS8111	20 x 20	10	25	400
YS8122	25 x 25	10	15	255
YS8133	32 x 32	10	10	160
YS8144	40 x 40	10	5	85
YS8155	50 x 50	10	4	48
YS8166	63 x 63	10	4	32
YS8177	75 x 75	6	2	16
YS8188	90 x 90	6	1	12
YS8199	110 x 110	6	1	6



**KABLİN DİRSEK**  
ELBOW

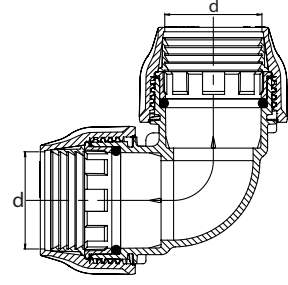

KOD CODE	EBAT / SIZE d x G	BASINÇ DEĞERİ PRESSURE VALUE PN	AMBALAJ ADEDİ PACKING QUANTITY	KOLİ ADEDİ BOX QUANTITY
YS8211	20 x 1/2"	10	25	650
YS8212	20 x 3/4"	10	25	600
YS8221	25 x 1/2"	10	15	420
YS8222	25 x 3/4"	10	15	390
YS8223	25 x 1"	10	15	360
YS8231	32 x 1/2"	10	10	260
YS8232	32 x 3/4"	10	10	260
YS8233	32 x 1"	10	10	240
YS8234	32 x 1 1/4"	10	10	210
YS8243	40 x 1"	10	5	140
YS8244	40 x 1 1/4"	10	5	130
YS8245	40 x 1 1/2"	10	5	120
YS8254	50 x 1 1/4"	10	4	80
YS8255	50 x 1 1/2"	10	4	80
YS8256	50 x 2"	10	4	68
YS8265	63 x 1 1/2"	10	4	52
YS8266	63 x 2"	10	4	48
YS8267	63 x 2 1/2"	10	4	40
YS8276	75 x 2"	6	2	28
YS8277	75 x 2 1/2"	6	2	26
YS8278	75 x 3"	6	2	24
YS8287	90 x 2 1/2"	6	1	18
YS8288	90 x 3"	6	1	18
YS8289	90 x 4"	6	1	15
YS8298	110 x 3"	6	1	10
YS8299	110 x 4"	6	1	10



**KABLİN ERKEK DİRSEK**  
MALE ELBOW

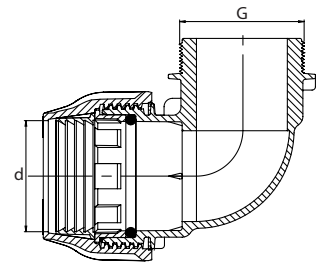

# YEŞİL SERİ / GREEN SERIES COMPRESSION FITTINGS



**KABLİN  
REDÜKSİYON TE**  
REDUCING TEE

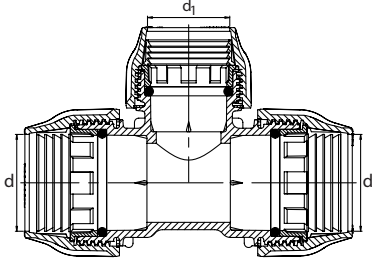

KOD CODE	EBAT / SIZE d x d <sub>1</sub> x d	BASINÇ DEĞERİ PRESSURE VALUE PN	AMBALAJ ADEDİ PACKING QUANTITY	KOLİ ADEDİ BOX QUANTITY
YS8612	20 x 25 x 20	10	10	200
YS8621	25 x 20 x 25	10	10	190
YS8623	25 x 32 x 25	10	10	120
YS8631	32 x 20 x 32	10	5	120
YS8632	32 x 25 x 32	10	5	110
YS8642	40 x 25 x 40	10	5	65
YS8643	40 x 32 x 40	10	5	60
YS8652	50 x 25 x 50	10	4	48
YS8653	50 x 32 x 50	10	4	48
YS8654	50 x 40 x 50	10	4	40
YS8663	63 x 32 x 63	10	3	30
YS8664	63 x 40 x 63	10	3	27
YS8665	63 x 50 x 63	10	3	24
YS8675	75 x 50 x 75	6	1	16
YS8676	75 x 63 x 75	6	1	16
YS8686	90 x 63 x 90	6	1	9
YS8687	90 x 75 x 90	6	1	9
YS8696	110 x 63 x 110	6	1	7
YS8698	110 x 90 x 110	6	1	5



**KABLİN REDÜKSİYON  
MANŞON**  
REDUCING COUPLING

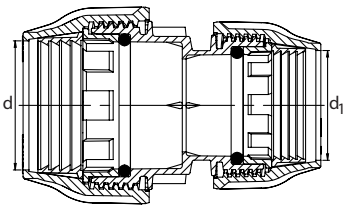

KOD CODE	EBAT / SIZE d x d <sub>1</sub>	BASINÇ DEĞERİ PRESSURE VALUE PN	AMBALAJ ADEDİ PACKING QUANTITY	KOLİ ADEDİ BOX QUANTITY
YS8721	25 x 20	10	25	350
YS8731	32 x 20	10	10	270
YS8732	32 x 25	10	10	220
YS8741	40 x 20	10	10	140
YS8742	40 x 25	10	10	140
YS8743	40 x 32	10	10	120
YS8752	50 x 25	10	6	96
YS8753	50 x 32	10	6	90
YS8754	50 x 40	10	6	78
YS8763	63 x 32	10	6	72
YS8764	63 x 40	10	6	60
YS8765	63 x 50	10	6	48
YS8775	75 x 50	6	2	32
YS8776	75 x 63	6	2	28
YS8786	90 x 63	6	2	20
YS8787	90 x 75	6	2	16
YS8797	110 x 75	6	1	12
YS8798	110 x 90	6	1	10

## YEŞİL SERİ / GREEN SERIES COMPRESSION FITTINGS

KOD CODE	EBAT / SIZE d x d <sub>1</sub>	BASINÇ DEĞERİ PRESSURE VALUE PN	AMBALAJ ADEDİ PACKING QUANTITY	KOLİ ADEDİ BOX QUANTITY
YS8921	25 x 20	10	15	330
YS8932	32 x 25	10	10	200
YS8943	40 x 32	10	5	110
YS8954	50 x 40	10	4	64
YS8965	63 x 50	10	4	40
YS8976	75 x 63	6	2	22
YS8987	90 x 75	6	1	14
YS8998	110 x 90	6	1	8



**KABLİN  
REDÜKSİYON DİRSEK**  
REDUCING ELBOW

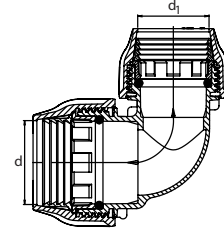

KOD CODE	EBAT / SIZE d	BASINÇ DEĞERİ PRESSURE VALUE PN	AMBALAJ ADEDİ PACKING QUANTITY	KOLİ ADEDİ BOX QUANTITY
YS8811	20	10	50	800
YS8822	25	10	25	550
YS8833	32	10	25	350
YS8844	40	10	15	195
YS8855	50	10	12	120
YS8866	63	10	6	84
YS8877	75	6	4	40
YS8888	90	6	4	24
YS8899	110	6	2	14



**KABLİN KÖR TAPA**  
END CAP

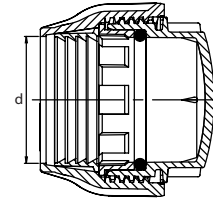

**KABLİN ANAHTARI**  
FITTING SPANNER

KOD CODE	EBAT SIZE-mm	AMBALAJ ADEDİ PACKING QUANTITY	KOLİ ADEDİ BOX QUANTITY
4936	32 - 63	5	140
4969	63 - 110	5	45



# ISO 17885 STANDARTI - TESTLER

## ISO 17885 STANDARD - TESTS

**PLASTİK MALZEMENİN UZUN VADEDE DAVRANIŞININ DOĞRULANMASI**  
*Ekleme parçalarının gövdeleri, ISO 1167-1 test standardına göre test edilmektedir.*

**VERIFICATION OF LONG-TERM BEHAVIOUR OF THE PLASTIC MATERIAL**  
*Compression fittings bodies are tested according to the ISO 1167-1 test standard.*

MALZEME MATERIAL	TEST SICAKLIĞI / °C TEST TEMPERATURE	TEST SÜRESİ / SAAT TEST DURATION / HOUR	TEST BASINCI / BAR TEST PRESSURE
PP-H	<u>20</u> 95	<u>1</u> 1.000	<u>20.0</u> 3.4

**İÇ BASINÇ ALTINDA UZUN SÜRELİ SIZDIRMAZLIK**  
*Montajlanmış ekleme parçaları, ISO 3458, ISO 1167-1, ISO 1167-4 test standardına göre test edilmektedir.*

**LONG-TERM LEAKPROOFNESS UNDER INTERNAL PRESSURE**  
*Assembled fittings are tested according to the ISO 3458, ISO 1167-1, ISO 1167-4 test standard.*

TEST SICAKLIĞI / °C TEST TEMPERATURE	TEST SÜRESİ / SAAT TEST DURATION / HOUR	TEST BASINCI / BAR TEST PRESSURE
<u>20 ± 5</u>	<u>1.000</u>	<u>12.0</u>





## 23 °C SICAKLIKTA AYRILMA DİRENCİ

*PE boru ile montajlanmış ekleme parçaları, ISO 3501 test standardına göre test edilmektedir.*

**RESISTANCE TO PULL-OUT AT 23 °C**  
*Compression fittings, assembled with PE pipes, are tested according to the ISO 3501 test standard.*

Yeşil Seri için 1 Saat Çekme Kuvveti (Newton) 1 Hour Pulling Force for Green Series (Newton)

Ø20	Ø25	Ø32	Ø40	Ø50	Ø63	Ø75	Ø90	Ø110
1.119	1.623	1.865	2.362	2.984	4.701	6.499	9.411	13.813

## İÇ BASINÇ ALTINDA SIZDIRMAZLIK

*Montajlanmış ekleme parçaları, ISO 3458 test standardına göre test edilmektedir.*

**LEAKPROOFNESS UNDER INTERNAL PRESSURE**  
*Assembled fittings are tested according to the ISO 3458 test standard.*

TEST SICAKLIĞI / °C TEST TEMPERATURE	TEST SÜRESİ / SAAT TEST DURATION / HOUR	TEST BASINCI / BAR TEST PRESSURE
20 ± 5	1.0	15.0
20 ± 5	1.0	*24.0

\*Özel Test / Special Test



## BÜKÜLÜ İKEN İÇ BASINÇ ALTINDA SIZDIRMAZLIK

*Ø 20-63 mm Montajlanmış ekleme parçaları, ISO 3503 test standardına göre test edilmektedir.*

**LEAKPROOFNESS UNDER INTERNAL PRESSURE WHEN TWISTED**  
*Ø 20-63 mm Assembled fittings are tested according to the ISO 3503 test standard.*

TEST SICAKLIĞI / °C TEST TEMPERATURE	TEST SÜRESİ / SAAT TEST DURATION / HOUR	TEST BASINCI / BAR TEST PRESSURE
23 ± 2	1.0	15.0

**DİŞLER** Ekleme parçaları için dişler, ISO 7-1 standardına uygundur.

**THREADS** Threads for compression fittings are covered by ISO 7-1 standard.

**SU KALİTESİ ÜZERİNDEKİ ETKİSİ** Ekleme parçaları, içme suyu üzerinde mikroorganizmaların çoğalmalarına izin vermemelidir. KIWA ve TSE kuruluşlarının laboratuvarları tarafından ilgili testler yapılarak raporlandırılmıştır.

**INFLUENCE ON WATER QUALITY** Compression fittings must not allow increasing microorganism on drinking water. It is reported with the related tests by the laboratories of KIWA and TSE Institutions.

# MAVİ SERİ /YEŞİL SERİ

## BLUE, GREEN SERIES COMPRESSION FITTINGS

### DİKKAT EDİLMESİ GEREKEN HUSUSLAR

- + Poelsan boru bağlantı adaptörleri depolama ve montaj esnasında sert ve keskin cisimlerden uzak tutulmalıdır. Tesisat toprak altına döşenecekse, sert ve keskin cisimlerden korumak amacıyla kum ile kapatılmalıdır. Kesinlikle hasar görmüş adaptörler kullanılmamalıdır.
- + Poelsan boru bağlantı adaptörlerinden maksimum verim alabilmek için, te ve dirsekler 90°, diğer adaptörler 180° açı yapacak şekilde boruya monte edilmelidir. Değişik açılar oluşturan bağlantılar adaptör üzerinde gerilmelere neden olacağından tesisatın ömrü azalacaktır.
- + Dişli bağlantılarda teflon bant kullanılmalıdır. Teflon bant adaptöre su sızıntısını önleyecek kadar ve sıkma yönünde sarılmalıdır.
- + Montaj esnasında somunun fazla sıkılması adaptör üzerinde ek bir gerilmeye neden olur. Bu şekilde ek bir gerilmeye maruz kalmış olan ürünün garanti verilen basınç değerlerini karşılaması beklenemez. Bu nedenle ürünün plastik olduğu ve sadece sızdırmazlığı sağlayacak kuvvette sıkılması gerektiği unutulmamalıdır.

### POINTS TO TAKE INTO CONSIDERATION

- + Poelsan compression fittings should be kept away from hard or sharp objects during storage or installation phases. If the installation will be under the ground, it should be covered with sand in order to keep away from contact with hard and sharp objects. Damaged fittings shouldn't be used strictly.
- + To be able to get the best efficiency from Poelsan compression fittings, tee and elbow pieces should be joined with 90°, other fittings should be joined with 180° to the system. The installation with different angles will make extra tensile on the fittings and will decrease the lifetime of the system.
- + Teflon band should be used with the threaded pieces. The band should be used enough to prevent water leakage and wrapped on the threaded part in the twisting direction.
- + Over twisting of the nut will cause extra tension on the adaptor. A nut, which is exposed to such an extra tension cannot provide the guaranteed pressure value. Therefore the user should remember that the material is plastic and the nut should be twisted with a force only enough to prevent leakage.

# MAVİ SERİ /YEŞİL SERİ

## BLUE, GREEN SERIES COMPRESSION FITTINGS

### Tesisatın Son Kontrolü

#### GÖZLE KONTROL

Tesisatın döşenmesi sırasında hasar görmüş adaptörlerin tespiti için adaptörler mutlaka gözle kontrol edilmelidir.

#### SIZDIRMAZLIK KONTROLÜ

Tesisatın montajı sonrasında tesisata mutlaka test basıncında su verilmeli ve sızdırmazlık durumu tespit edilmelidir.

#### SIZINTIYA NEDEN OLABİLECEK UYGULAMALAR

Poelsan boru bağlantı adaptörlerinin dış ölçüleri standartlara uygun olarak üretilmiştir.

- Kullanılan diğer metal ya da plastik malzemenin uygun olmaması,
- Teflon bandın yeterli miktarda kullanılmaması,
- Ürünün aşırı miktarda sıkılması ya da montaj esnasında düzgün monte edilmemesi sonucu ürünün dışlarının bozulması,
- Montaj esnasında oringin zarar görmesi ya da oringin yerinden çıkması,
- Borulardaki ovalliğin verilen tolerans değerlerinden daha fazla olması,
- Somunun yanlış monte edilmesi, yeterli miktarda sıkılmaması ya da çok fazla sıkılarak ürünün çatlaması,
- Boru tutucunun oring tutucu ile birleştirilmeden somunun sıkılarak adaptörün montajının yapılması,

tesisatınızda sızıntıya neden olabilir.

### Final Check of the Installation

#### VISUAL CHECK

During installation, the system should be checked visually in order to determine the damaged adaptors.

#### LEAKPROOFNESS CHECK

After the installation, the system should be checked with water in testing pressure to determine the water leak.

#### CONDITIONS THAT MAY CAUSE LEAKAGE

The measurements of the threads of Poelsan compression fittings are produced according to the standards.

- Unfitness of the measurements of the threads of other metal or plastic material,
- Unefficient use of the teflon band,
- Spoiling of the threads because of the improper installation or over twisting of the nut,
- Not chamfering the pipe during assembly causes the oring to be damaged, or dislocated,
- The ovality of pipes is more than the tolerance values,
- Wrong installation, inefficient twisting or cracking the nut by over twisting,
- Twisting the nut and installing the adaptor without joining the locking ring and the o-ring holder,

may cause leakage in the system.



# YEŞİL SERİ ADAPTÖRLERİN MONTAJ YÖNTEMLERİ

## GREEN SERIES INSTALLATION METHODS

### 1. MONTAJ YÖNTEMİ / INSTALLATION METHOD

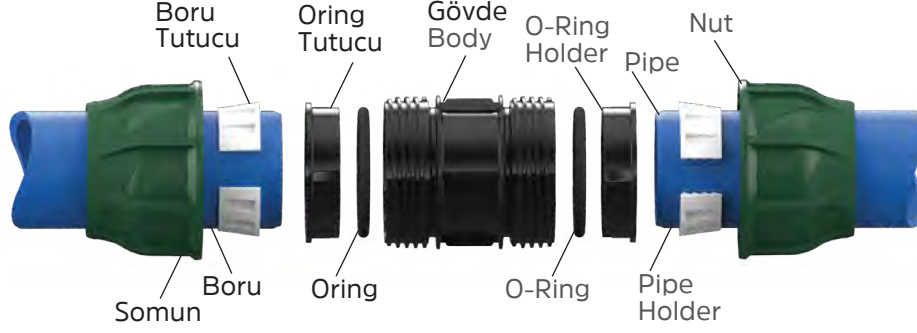

- 1 **Boru uçlarına yaklaşık 15° pah açınız.**  
Make chamfer on the pipe ends. (Approximately 15°)



- 3 **Adaptörünüzün somununu yaklaşık 2 tam tur döndürüp gevşetiniz.**  
Untwist 2 full rounds and loosen the nut of the fitting.



- 5 **Somunu Poelsan Kablo Anahtarı ile sıkınız.**  
Twist the nut with Poelsan Fitting Spanner.



- 2 **Boru üzerini, borunun adaptöre geçiş mesafesine göre işaretleyiniz.**  
Mark the pipe, according to the pipe end point inside the fitting.

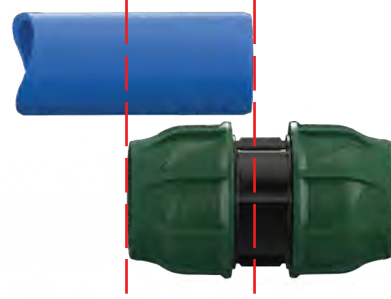

- 4 **Boruyu, adaptörünüzün iç kısmındaki \* boru dayanma noktasına kadar iyice itiniz.**  
Push the pipe to \* the pipe end point inside the fitting.

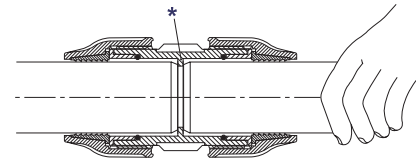

# YEŞİL SERİ ADAPTÖRLERİN MONTAJ YÖNTEMLERİ

## GREEN SERIES INSTALLATION METHODS

( Ø63, Ø75, Ø90, Ø110 mm adaptörler / adaptors)

(Standart dışı borularda ve montaj zorluğu yaşanan alanlarda tavsiye edilen yöntemdir. )

( It is the recommended method for non-standard pipes and areas where installation is difficult.)

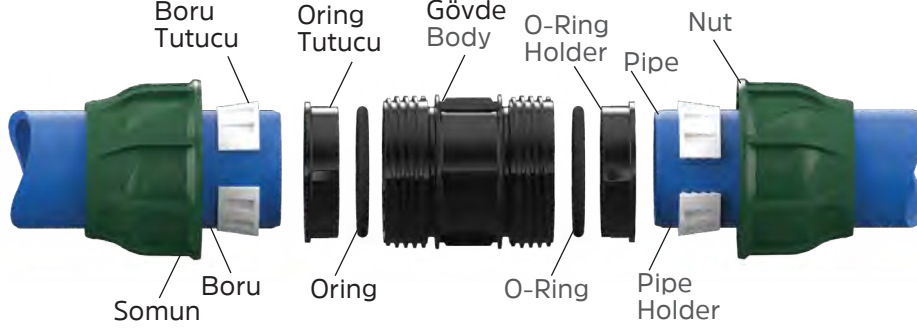

## 2. MONTAJ YÖNTEMİ / INSTALLATION METHOD

### 1 Pah açmaya gerek yoktur.

There is no need to make chamfer on the pipe end.

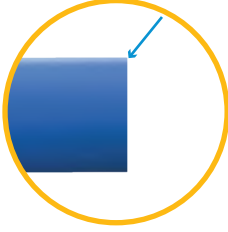

### 2 Boru üzerini, borunun adaptöre geçiş mesafesine göre işaretleyiniz.

Mark the pipe, according to the pipe end point inside the fitting.

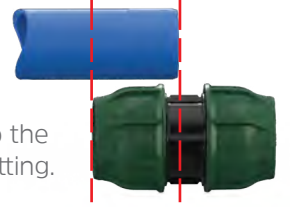

### 3 Boruya sırasıyla; önce somunu, sonra oring tutucu ve oringi takınız.

Place the nut, o-ring holder and the o-ring on the pipe respectively.



### 4 Boruyu, adaptörünüzün iç kısmındaki \* boru dayanma noktasına kadar iyice itiniz.

Push the pipe to \* the pipe end point inside the fitting.

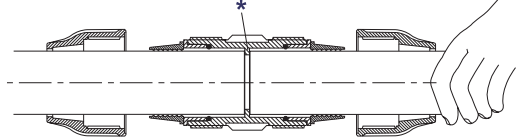

### 5 Somunu sıkarak adaptörünüzle birleştiriniz. Bu işlem oring ve oring tutucunun kolayca takılmasını sağlayacaktır.

Twist the nut till it is attached to the fitting. This will help the o-ring and the o-ring holder to be placed easily.



### 6 Somunu gevşeterek açınız.

Untwist and loosen the nut from the fitting.



### 7 Boru tutucuyu borunun çapı kadar esneterek boruya takınız. Boru üzerinde kaydırarak oring tutucu ile birleştiriniz.

Stretch the locking ring to the diameter of the pipe. Place it on the pipe by sliding it to the o-ring holder.

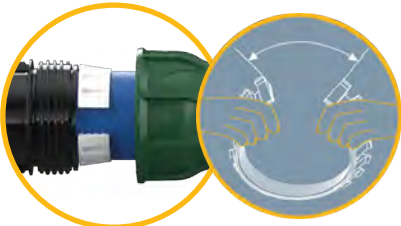

### 8 Somunu Poelsan Kablo Anahtarı ile sıkınız.

Twist the nut with Poelsan Fitting Spanner.



# MAVİ SERİ ADAPTÖRLERİN MONTAJ YÖNTEMLERİ

## BLUE SERIES INSTALLATION METHODS

(Ø20, Ø25, Ø32, Ø40, Ø50, mm adaptörler / adaptors)

### I MONTAJ YÖNTEMİ / INSTALLATION METHOD

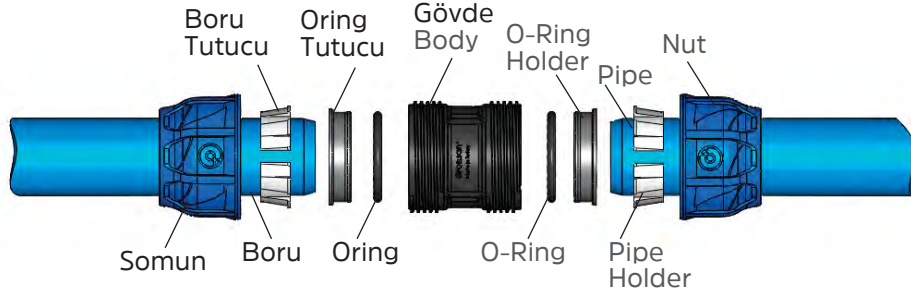

- 1** Boru uçlarına yaklaşık 15° pah açınız.  
Make chamfer on the pipe ends. (Approximately 15°)



- 3** Adaptörünüzün somununu yaklaşık 3 tam tur döndürüp gevşetiniz.  
Untwist 3 full rounds and loosen the nut of the fitting.



- 5** Somunu Poelsan Kablo Anahtarı ile sıkınız.  
Twist the nut with Poelsan Fitting Spanner.



- 2** Boru üzerini, borunun adaptöre geçiş mesafesine göre işaretleyiniz.  
Mark the pipe, according to the pipe end point inside the fitting.



- 4** Boruyu, adaptörünüzün iç kısmındaki \* boru dayanma noktasına kadar iyice itiniz.  
Push the pipe to \* the pipe end point inside the fitting.

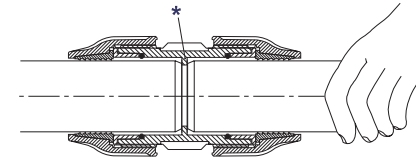

# MAVİ SERİ ADAPTÖRLERİN MONTAJ YÖNTEMLERİ

## BLUE SERIES INSTALLATION METHODS

( Ø63, Ø75, Ø90, Ø110, Ø125 mm adaptörler / adaptors)

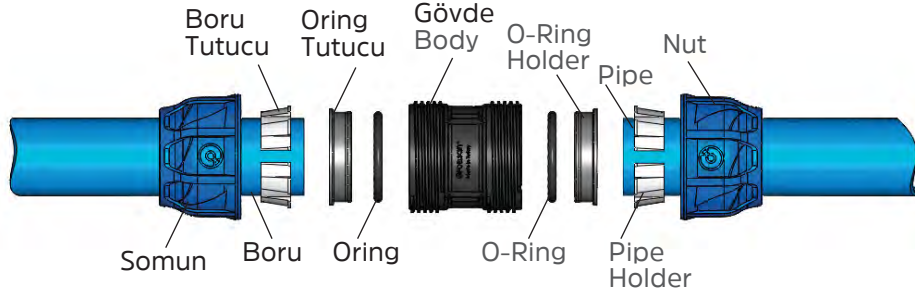

### I MONTAJ YÖNTEMİ / INSTALLATION METHOD

**1** Pah açmaya gerek yoktur.

There is no need to make chamfer on the pipe end.

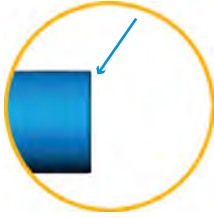

**2**

**Boru üzerini, borunun adaptöre geçiş mesafesine göre işaretleyiniz.**

Mark the pipe, according to the pipe end point inside the fitting.



**3** Boruya sırasıyla; önce somunu, sonra oring tutucu ve oringi takınız.

Place the nut, o-ring holder and the o-ring on the pipe respectively.



**4**

**Boruyu, adaptörünüzün iç kısmındaki \* boru dayanma noktasına kadar iyice itiniz.**

Push the pipe to \* the pipe end point inside the fitting.

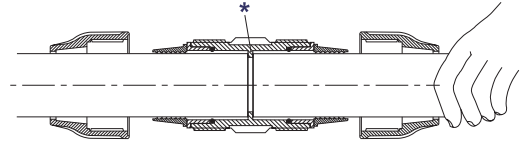

**5**

**Somunu sıkarak adaptörünüzle birleştiriniz. Bu işlem oring ve oring tutucunun kolayca takılmasını sağlayacaktır.**

Twist the nut till it is attached to the fitting. This will help the o-ring and the o-ring holder to be placed easily.



**6**

**Somunu gevşeterek açınız.**

Untwist and loosen the nut from the fitting.



**7**

**Boru tutucuyu borunun çapı kadar esneterek boruya takınız. Boru üzerinde kaydırarak oring tutucu ile birleştiriniz.**

Stretch the locking ring to the diameter of the pipe. Place it on the pipe by sliding it to the o-ring holder.

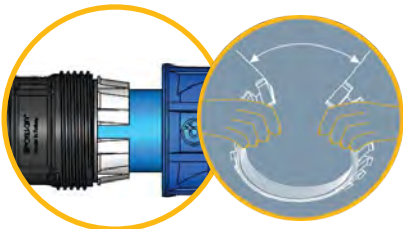

**8**

**Somunu Poelsan Kablo Anahtarı ile sıkınız.**

Twist the nut with Poelsan Fitting Spanner.





# YEŞİL SERİ

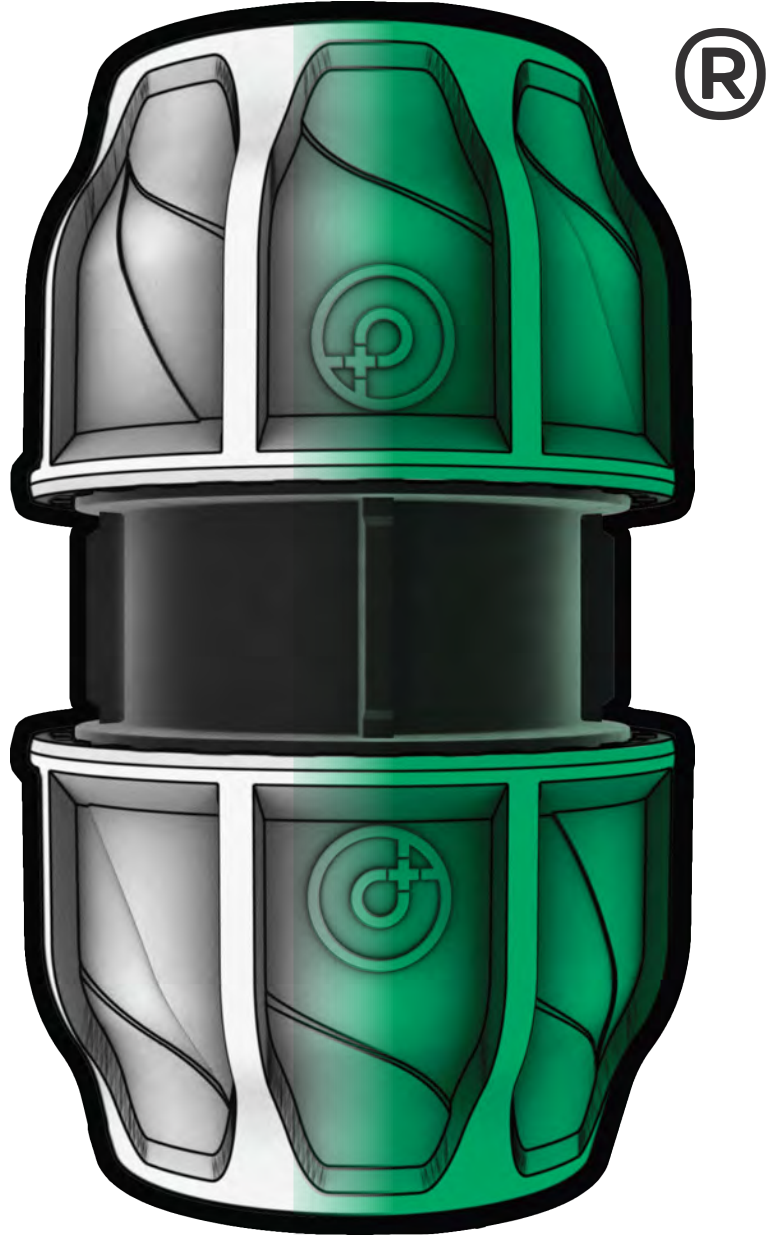

POELSAN®

# GREEN SERIES

## PRİZ KOLYE CLAMP SADDLES

### Özellikler

- + Darbelere karşı dayanıklı, yüksek kaliteli polipropilen hammaddeden üretilmiştir.
- + Borulardaki ölçü farklılıklarından doğabilecek sızıntıları önleyebilecek şekilde tasarlanmıştır.
- + Oringi kauçuktan üretilmekte olup yüksek basınç altında sızdırmazlık sağlar.
- + Ürünlerimizde kullanılan korozyona dayanıklı metal yüzük sayesinde 50 °C'yi aşmayan sistemlerde güvenle kullanılabilir.
- + Suyun kokusunu ve tadını değiştirebilecek zararlı bileşikler içermez.
- + İçme suyunda kullanıma uygundur.
- + Metal yüzük, cıvata, somun ve pullar paslanmaz çelik ve galvaniz olarak çeşitlendirilmiştir.
- + Somunlar, alt kapaktaki yuvalarına yerleştirildiği için hızlı ve kolay montaj yapılmasını sağlar.
- + Diş ölçüleri ISO 7-1 Standardına uygundur.
- + ISO 13460-1 Standardına uygundur.

### KULLANIM ALANLARI

- + Şehir Şebekesi İçme Suyu
- + Peyzaj Sektörü
- + Tarımsal Sulama
- + Seralar

### INSTALLATION AREAS

- + Urban Potable Water Networks
- + Landscaping Systems
- + Agricultural Irrigation
- + Greenhouses

### GARANTİ VERİLEN BASINÇ DEĞERLERİ

#### GUARANTEED PRESSURE VALUES

Ø 25 mm – Ø 110 mm	: PN 16
2"	: PN 10
Ø 125 mm – Ø 225 mm	: PN 10
3" – 4"	: PN 6

### Specifications

- + It has been produced from high quality polypropylene raw material and it has resistance to impact.
- + It is designed to prevent leakage caused by the size differences of the pipes.
- + O-rings are made of rubber and provide leakproofness under high pressure.
- + Thanks to the corrosion resistant metal ring used in our products, it can be used safely in systems not exceeding 50 °C.
- + It does not contain any harmful compounds which can change the taste or the smell of the water.
- + It is suitable to be used for drinking water.
- + Reinforcing ring, bolt, nut and washers are varied as stainless steel and galvanized.
- + Because the nuts are inserted in their housing on the lower part, it provides quick and easy installation.
- + Thread sizes are compatible with ISO 7-1 Standard.
- + It is compatible with ISO 13460-1 Standard.



TS ISO 13460-1



# PRİZ KOLYE /CLAMP SADDLES



## PRİZ KOLYE GALVANİZ CIVATALI & METAL YÜZÜKLÜ

CLAMP SADDLE  
WITH GALVANIZED  
BOLT & REINFORCING RING

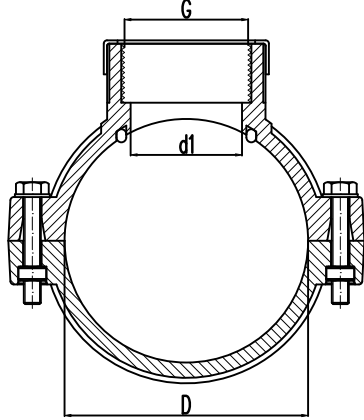

KOD CODE	EBAT / SIZE D x G	CIVATA ADEDİ BOLT QUANTITY	BASINÇ DEĞERİ PRESSURE VALUE PN	AMBALAJ ADEDİ PACKING QUANTITY	KOLİ ADEDİ BOX QUANTITY
100120201	25 x 1/2"	2	16	25	300
100120202	25 x 3/4"	2	10	25	300
100120301	32 x 1/2"	2	16	25	250
100120302	32 x 3/4"	2	16	25	250
100120303	32 x 1"	2	16	25	250
100120401	40 x 1/2"	2	16	25	200
100120402	40 x 3/4"	2	16	25	175
100120403	40 x 1"	2	10	25	175
100120501	50 x 1/2"	2	16	10	160
100120502	50 x 3/4"	2	16	10	150
100120503	50 x 1"	2	16	10	130
100120504	50 x 1 1/4"	2	10	10	130
100120601	63 x 1/2"	4	16	10	110
100120602	63 x 3/4"	4	16	10	110
100120603	63 x 1"	4	16	10	100
100120604	63 x 1 1/4"	4	16	10	80
100120605	63 x 1 1/2"	4	16	10	80
100120701	75 x 1/2"	4	16	5	85
100120702	75 x 3/4"	4	16	5	85
100120703	75 x 1"	4	16	5	80
100120704	75 x 1 1/4"	4	16	5	55
100120705	75 x 1 1/2"	4	16	5	55
100120706	75 x 2"	4	10	5	50
100120801	90 x 1/2"	4	16	5	75
100120802	90 x 3/4"	4	16	5	70
100120803	90 x 1"	4	16	5	60
100120804	90 x 1 1/4"	4	16	5	40
100120805	90 x 1 1/2"	4	16	5	40
100120806	90 x 2"	4	10	5	40
100120901	110 x 1/2"	4	16	5	55
100120902	110 x 3/4"	4	16	5	55
100120903	110 x 1"	4	16	5	50
100120904	110 x 1 1/4"	4	16	5	35
100120905	110 x 1 1/2"	4	16	5	35
100120906	110 x 2"	4	10	5	30
100121001	125 x 1/2"	4	10	2	44
100121002	125 x 3/4"	4	10	2	44
100121003	125 x 1"	4	10	2	40
100121004	125 x 1 1/4"	4	10	2	40
100121005	125 x 1 1/2"	4	10	2	40
100121006	125 x 2"	4	10	2	40

KOD CODE	EBAT / SIZE D x G	CIVATA ADEDİ BOLT QUANTITY	BASINÇ DEĞERİ PRESSURE VALUE PN	AMBALAJ ADEDİ PACKING QUANTITY	KOLİ ADEDİ BOX QUANTITY
100121101	140 x ½"	6	10	2	36
100121102	140 x ¾"	6	10	2	36
100121103	140 x 1"	6	10	2	36
100121104	140 x 1 ¼"	6	10	2	36
100121105	140 x 1 ½"	6	10	2	36
100121106	140 x 2"	6	10	2	28
100121201	160 x ½"	6	10	2	26
100121202	160 x ¾"	6	10	2	26
100121203	160 x 1"	6	10	2	26
100121204	160 x 1 ¼"	6	10	2	24
100121205	160 x 1 ½"	6	10	2	24
100121206	160 x 2"	6	10	2	22
100121207	160 x 2 ½"	6	10	2	16
100121208	160 x 3"	6	6	2	12
100121209	160 x 4"	6	6	2	12
100121302	180 x ¾"	6	10	2	10
100121303	180 x 1"	6	10	2	10
100121304	180 x 1 ¼"	6	10	2	10
100121305	180 x 1 ½"	6	10	2	10
100121306	180 x 2"	6	10	2	10
100121307	180 x 2 ½"	6	10	2	10
100121308	180 x 3"	6	6	2	10
100121309	180 x 4"	6	6	2	8
100121402	200 x ¾"	6	10	2	10
100121403	200 x 1"	6	10	2	10
100121404	200 x 1 ¼"	6	10	2	10
100121405	200 x 1 ½"	6	10	2	10
100121406	200 x 2"	6	10	2	8
100121407	200 x 2 ½"	6	10	2	8
100121408	200 x 3"	6	6	2	8
100121409	200 x 4"	6	6	2	8
100121503	225 x 1"	6	10	2	8
100121504	225 x 1 ¼"	6	10	2	8
100121505	225 x 1 ½"	6	10	2	8
100121506	225 x 2"	6	10	2	8
100121507	225 x 2 ½"	6	10	2	8
100121508	225 x 3"	6	6	2	8
100121509	225 x 4"	6	6	2	8



## PRİZ KOLYE GALVANİZ CIVATALI & METAL YÜZÜKLÜ

CLAMP SADDLE  
WITH GALVANIZED  
BOLT & REINFORCING RING

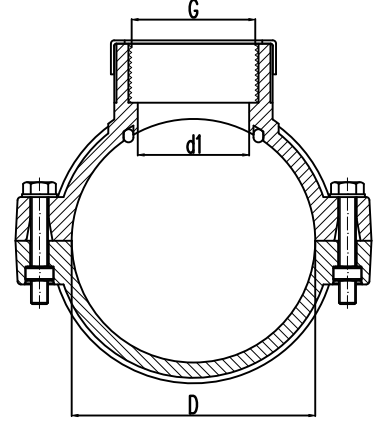

## PRİZ KOLYE / CLAMP SADDLES



### PRİZ KOLYE ÇİFT ÇIKIŞLI GALVANİZ CIVATALI & METAL YÜZÜKLÜ

DOUBLE ENDED CLAMP SADDLE  
WITH GALVANIZED  
BOLT & REINFORCING RING

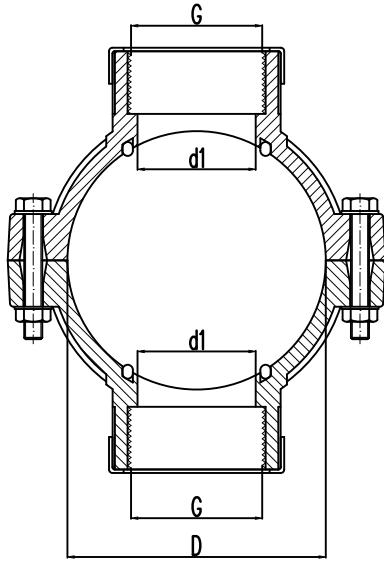

KOD CODE	EBAT / SIZE D x G	CIVATA ADEDİ BOLT QUANTITY	BASINÇ DEĞERİ PRESSURE VALUE PN	AMBALAJ ADEDİ PACKING QUANTITY	KOLİ ADEDİ BOX QUANTITY
100140201	25 x 1/2" x 1/2"	2	16	25	250
100140301	32 x 1/2" x 1/2"	2	16	25	200
100140302	32 x 3/4" x 3/4"	2	16	25	200
100140401	40 x 1/2" x 1/2"	2	16	25	200
100140402	40 x 3/4" x 3/4"	2	16	25	150
100140501	50 x 1/2" x 1/2"	2	16	10	140
100140502	50 x 3/4" x 3/4"	2	16	10	120
100140503	50 x 1" x 1"	2	16	10	120
100140601	63 x 1/2" x 1/2"	4	16	10	90
100140602	63 x 3/4" x 3/4"	4	16	10	90
100140603	63 x 1" x 1"	4	16	10	80
100140604	63 x 1 1/4" x 1 1/4"	4	16	10	50
100140605	63 x 1 1/2" x 1 1/2"	4	16	10	50
100140701	75 x 1/2" x 1/2"	4	16	5	80
100140702	75 x 3/4" x 3/4"	4	16	5	80
100140703	75 x 1" x 1"	4	16	5	70
100140704	75 x 1 1/4" x 1 1/4"	4	16	5	40
100140705	75 x 1 1/2" x 1 1/2"	4	16	5	40
100140706	75 x 2" x 2"	4	10	5	40
100140801	90 x 1/2" x 1/2"	4	16	5	60
100140802	90 x 3/4" x 3/4"	4	16	5	60
100140803	90 x 1" x 1"	4	16	5	50
100140804	90 x 1 1/4" x 1 1/4"	4	16	5	35
100140805	90 x 1 1/2" x 1 1/2"	4	16	5	35
100140806	90 x 2" x 2"	4	10	5	30
100140901	110 x 1/2" x 1/2"	4	16	5	50
100140902	110 x 3/4" x 3/4"	4	16	5	50
100140903	110 x 1" x 1"	4	16	5	40
100140904	110 x 1 1/4" x 1 1/4"	4	16	5	30
100140905	110 x 1 1/2" x 1 1/2"	4	16	5	30
100140906	110 x 2" x 2"	4	10	5	30
100141001	125 x 1/2" x 1/2"	4	10	2	50
100141002	125 x 3/4" x 3/4"	4	10	2	48
100141003	125 x 1" x 1"	4	10	2	42
100141004	125 x 1 1/4" x 1 1/4"	4	10	2	42
100141005	125 x 1 1/2" x 1 1/2"	4	10	2	36
100141006	125 x 2" x 2"	4	10	2	34



KOD CODE	EBAT / SIZE D x G	CIVATA ADEDİ BOLT QUANTITY	BASINÇ DEĞERİ PRESSURE VALUE PN	AMBALAJ ADEDİ PACKING QUANTITY	KOLİ ADEDİ BOX QUANTITY
100141101	140 x 1/2" x 1/2"	6	10	2	36
100141102	140 x 3/4" x 3/4"	6	10	2	34
100141103	140 x 1" x 1"	6	10	2	28
100141104	140 x 1 1/4" x 1 1/4"	6	10	2	26
100141105	140 x 1 1/2" x 1 1/2"	6	10	2	22
100141106	140 x 2" x 2"	6	10	2	22
100141201	160 x 1/2" x 1/2"	6	10	2	26
100141202	160 x 3/4" x 3/4"	6	10	2	26
100141203	160 x 1" x 1"	6	10	2	24
100141204	160 x 1 1/4" x 1 1/4"	6	10	2	22
100141205	160 x 1 1/2" x 1 1/2"	6	10	2	20
100141206	160 x 2" x 2"	6	10	2	20
100141207	160 x 2 1/2" x 2 1/2"	6	10	2	12
100141208	160 x 3" x 3"	6	6	2	12
100141209	160 x 4" x 4"	6	6	2	10
100141302	180 x 3/4" x 3/4"	6	10	2	10
100141303	180 x 1" x 1"	6	10	2	10
100141304	180 x 1 1/4" x 1 1/4"	6	10	2	10
100141305	180 x 1 1/2" x 1 1/2"	6	10	2	10
100141306	180 x 2" x 2"	6	10	2	10
100141307	180 x 2 1/2" x 2 1/2"	6	10	2	8
100141308	180 x 3" x 3"	6	6	2	8
100141309	180 x 4" x 4"	6	6	2	6
100141402	200 x 3/4" x 3/4"	6	10	2	10
100141403	200 x 1" x 1"	6	10	2	10
100141404	200 x 1 1/4" x 1 1/4"	6	10	2	10
100141405	200 x 1 1/2" x 1 1/2"	6	10	2	8
100141406	200 x 2" x 2"	6	10	2	8
100141407	200 x 2 1/2" x 2 1/2"	6	10	2	8
100141408	200 x 3" x 3"	6	6	2	8
100141409	200 x 4" x 4"	6	6	2	6
100141503	225 x 1" x 1"	6	10	2	8
100141504	225 x 1 1/4" x 1 1/4"	6	10	2	8
100141505	225 x 1 1/2" x 1 1/2"	6	10	2	8
100141506	225 x 2" x 2"	6	10	2	8
100141507	225 x 2 1/2" x 2 1/2"	6	10	2	8
100141508	225 x 3" x 3"	6	6	2	8
100141509	225 x 4" x 4"	6	6	2	4



## PRİZ KOLYE ÇİFT ÇIKIŞLI GALVANİZ CIVATALI & METAL YÜZÜKLÜ

DOUBLE ENDED CLAMP SADDLE  
WITH GALVANIZED  
BOLT & REINFORCING RING

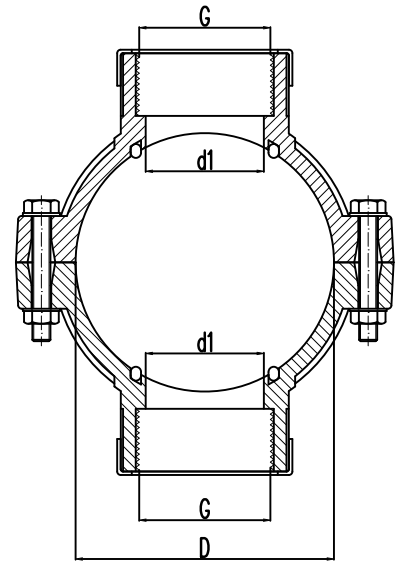



**PRİZ KOLYE  
PASLANMAZ CIVATALI  
(AISI304)  
PASLANMAZ METAL YÜZÜKLÜ  
(AISI430)**

CLAMP SADDLE  
WITH STAINLESS STEEL BOLT  
(AISI304)  
STAINLESS STEEL REINFORCING RING  
(AISI430)

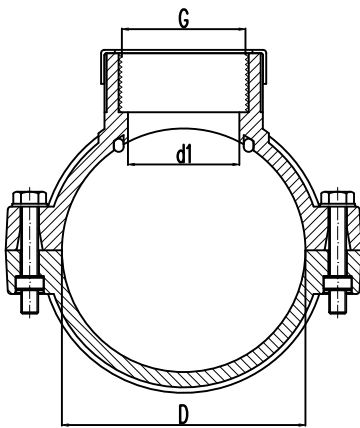

KOD CODE	EBAT / SIZE D x G	CIVATA ADEDİ BOLT QUANTITY	BASINÇ DEĞERİ PRESSURE VALUE PN	AMBALAJ ADEDİ PACKING QUANTITY	KOLİ ADEDİ BOX QUANTITY
100160201	25 x 1/2"	2	16	25	300
100160202	25 x 3/4"	2	10	25	300
100160301	32 x 1/2"	2	16	25	250
100160302	32 x 3/4"	2	16	25	250
100160401	40 x 1/2"	2	16	25	200
100160402	40 x 3/4"	2	16	25	175
100160403	40 x 1"	2	10	25	175
100160501	50 x 1/2"	2	16	10	160
100160502	50 x 3/4"	2	16	10	150
100160503	50 x 1"	2	16	10	130
100160504	50 x 1 1/4"	2	10	10	130
100160601	63 x 1/2"	4	16	10	110
100160602	63 x 3/4"	4	16	10	110
100160603	63 x 1"	4	16	10	100
100160604	63 x 1 1/4"	4	16	10	80
100160605	63 x 1 1/2"	4	16	10	80
100160701	75 x 1/2"	4	16	5	90
100160702	75 x 3/4"	4	16	5	90
100160703	75 x 1"	4	16	5	80
100160704	75 x 1 1/4"	4	16	5	55
100160705	75 x 1 1/2"	4	16	5	50
100160706	75 x 2"	4	10	5	50
100160801	90 x 1/2"	4	16	5	75
100160802	90 x 3/4"	4	16	5	70
100160803	90 x 1"	4	16	5	60
100160804	90 x 1 1/4"	4	16	5	40
100160805	90 x 1 1/2"	4	16	5	40
100160806	90 x 2"	4	10	5	40
100160901	110 x 1/2"	4	16	5	55
100160902	110 x 3/4"	4	16	5	55
100160903	110 x 1"	4	16	5	50
100160904	110 x 1 1/4"	4	16	5	35
100160905	110 x 1 1/2"	4	16	5	35
100160906	110 x 2"	4	10	5	30
100161001	125 x 1/2"	4	10	2	44
100161002	125 x 3/4"	4	10	2	44
100161003	125 x 1"	4	10	2	40
100161004	125 x 1 1/4"	4	10	2	40
100161005	125 x 1 1/2"	4	10	2	40
100161006	125 x 2"	4	10	2	40

KOD CODE	EBAT / SIZE D x G	CIVATA ADEDİ BOLT QUANTITY	BASINÇ DEĞERİ PRESSURE VALUE PN	AMBALAJ ADEDİ PACKING QUANTITY	KOLİ ADEDİ BOX QUANTITY
100161101	140 x ½"	6	10	2	36
100161102	140 x ¾"	6	10	2	36
100161103	140 x 1"	6	10	2	36
100161104	140 x 1 ¼"	6	10	2	36
100161105	140 x 1 ½"	6	10	2	36
100161106	140 x 2"	6	10	2	28
100161201	160 x ½"	6	10	2	26
100161202	160 x ¾"	6	10	2	26
100161203	160 x 1"	6	10	2	26
100161204	160 x 1 ¼"	6	10	2	24
100161205	160 x 1 ½"	6	10	2	24
100161206	160 x 2"	6	10	2	22
100161207	160 x 2 ½"	6	10	2	16
100161208	160 x 3"	6	6	2	12
100161209	160 x 4"	6	6	2	12
100161302	180 x ¾"	6	10	2	10
100161303	180 x 1"	6	10	2	10
100161304	180 x 1 ¼"	6	10	2	10
100161305	180 x 1 ½"	6	10	2	10
100161306	180 x 2"	6	10	2	10
100161307	180 x 2 ½"	6	10	2	10
100161308	180 x 3"	6	6	2	10
100161309	180 x 4"	6	6	2	8
100161402	200 x ¾"	6	10	2	10
100161403	200 x 1"	6	10	2	10
100161404	200 x 1 ¼"	6	10	2	10
100161405	200 x 1 ½"	6	10	2	10
100161406	200 x 2"	6	10	2	8
100161407	200 x 2 ½"	6	10	2	8
100161408	200 x 3"	6	6	2	8
100161409	200 x 4"	6	6	2	8
100161503	225 x 1"	6	10	2	8
100161504	225 x 1 ¼"	6	10	2	8
100161505	225 x 1 ½"	6	10	2	8
100161506	225 x 2"	6	10	2	8
100161507	225 x 2 ½"	6	10	2	8
100161508	225 x 3"	6	6	2	8
100161509	225 x 4"	6	6	2	8



**PRİZ KOLYE  
PASLANMAZ CIVATALI  
(AISI304)  
PASLANMAZ METAL YÜZÜKLÜ  
(AISI430)**

CLAMP SADDLE  
WITH STAINLESS STEEL BOLT  
(AISI304)  
STAINLESS STEEL REINFORCING RING  
(AISI430)

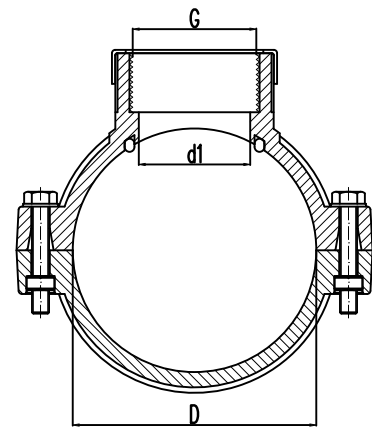



**PRİZ KOLYE ÇİFT ÇIKIŞLI  
PASLANMAZ CIVATALI  
(AISİ304)  
PASLANMAZ METAL YÜZÜKLÜ  
(AISİ430)**

DOUBLE ENDED CLAMP SADDLE  
WITH STAINLESS STEEL BOLT  
(AISİ304)  
STAINLESS STEEL  
REINFORCING RING  
(AISİ430)

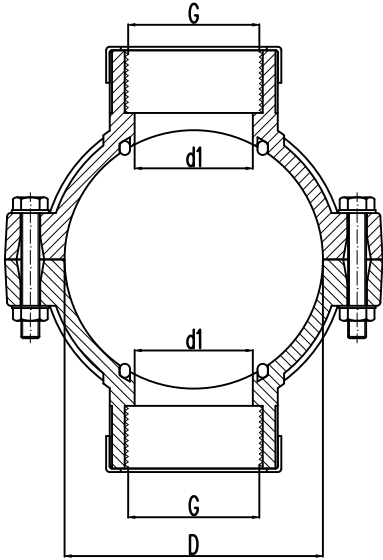

KOD CODE	EBAT / SIZE D x G	CIVATA ADEDİ BOLT QUANTITY	BASINÇ DEĞERİ PRESSURE VALUE PN	AMBALAJ ADEDİ PACKING QUANTITY	KOLİ ADEDİ BOX QUANTITY
100180201	25 x 1/2" x 1/2"	2	16	25	250
100180301	32 x 1/2" x 1/2"	2	16	25	200
100180302	32 x 3/4" x 3/4"	2	16	25	200
100180401	40 x 1/2" x 1/2"	2	16	25	150
100180402	40 x 3/4" x 3/4"	2	16	25	150
100180501	50 x 1/2" x 1/2"	2	16	10	140
100180502	50 x 3/4" x 3/4"	2	16	10	120
100180503	50 x 1" x 1"	2	16	10	120
100180601	63 x 1/2" x 1/2"	4	16	10	90
100180602	63 x 3/4" x 3/4"	4	16	10	90
100180603	63 x 1" x 1"	4	16	10	80
100180604	63 x 1 1/4" x 1 1/4"	4	16	10	50
100180605	63 x 1 1/2" x 1 1/2"	4	16	10	50
100180701	75 x 1/2" x 1/2"	4	16	5	80
100180702	75 x 3/4" x 3/4"	4	16	5	80
100180703	75 x 1" x 1"	4	16	5	70
100180704	75 x 1 1/4" x 1 1/4"	4	16	5	40
100180705	75 x 1 1/2" x 1 1/2"	4	16	5	40
100180706	75 x 2" x 2"	4	10	5	40
100180801	90 x 1/2" x 1/2"	4	16	5	60
100180802	90 x 3/4" x 3/4"	4	16	5	60
100180803	90 x 1" x 1"	4	16	5	50
100180804	90 x 1 1/4" x 1 1/4"	4	16	5	35
100180805	90 x 1 1/2" x 1 1/2"	4	16	5	35
100180806	90 x 2" x 2"	4	10	5	30
100180901	110 x 1/2" x 1/2"	4	16	5	50
100180902	110 x 3/4" x 3/4"	4	16	5	50
100180903	110 x 1" x 1"	4	16	5	40
100180904	110 x 1 1/4" x 1 1/4"	4	16	5	30
100180905	110 x 1 1/2" x 1 1/2"	4	16	5	30
100180906	110 x 2" x 2"	4	10	5	30
100181001	125 x 1/2" x 1/2"	4	10	2	50
100181002	125 x 3/4" x 3/4"	4	10	2	48
100181003	125 x 1" x 1"	4	10	2	42
100181004	125 x 1 1/4" x 1 1/4"	4	10	2	42
100181005	125 x 1 1/2" x 1 1/2"	4	10	2	36
100181006	125 x 2" x 2"	4	10	2	34

**PRİZ KOLYE (PASLANMAZ CIVATALI - AISI304) / CLAMP SADDLES (STAINLESS STEEL BOLT - AISI304)**

KOD CODE	EBAT / SIZE D x G	CIVATA ADEDİ BOLT QUANTITY	BASINÇ DEĞERİ PRESSURE VALUE PN	AMBALAJ ADEDİ PACKING QUANTITY	KOLİ ADEDİ BOX QUANTITY
100181101	140 x 1/2" x 1/2"	6	10	2	36
100181102	140 x 3/4" x 3/4"	6	10	2	34
100181103	140 x 1" x 1"	6	10	2	28
100181104	140 x 1 1/4" x 1 1/4"	6	10	2	26
100181105	140 x 1 1/2" x 1 1/2"	6	10	2	22
100181106	140 x 2" x 2"	6	10	2	22
100181201	160 x 1/2" x 1/2"	6	10	2	26
100181202	160 x 3/4" x 3/4"	6	10	2	26
100181203	160 x 1" x 1"	6	10	2	24
100181204	160 x 1 1/4" x 1 1/4"	6	10	2	22
100181205	160 x 1 1/2" x 1 1/2"	6	10	2	20
100181206	160 x 2" x 2"	6	10	2	20
100181207	160 x 2 1/2" x 2 1/2"	6	10	2	12
100181208	160 x 3" x 3"	6	6	2	12
100181209	160 x 4" x 4"	6	6	2	10
100181302	180 x 3/4" x 3/4"	6	10	2	10
100181303	180 x 1" x 1"	6	10	2	10
100181304	180 x 1 1/4" x 1 1/4"	6	10	2	10
100181305	180 x 1 1/2" x 1 1/2"	6	10	2	10
100181306	180 x 2" x 2"	6	10	2	10
100181307	180 x 2 1/2" x 2 1/2"	6	10	2	8
100181308	180 x 3" x 3"	6	6	2	8
100181309	180 x 4" x 4"	6	6	2	6
100181402	200 x 3/4" x 3/4"	6	10	2	10
100181403	200 x 1" x 1"	6	10	2	10
100181404	200 x 1 1/4" x 1 1/4"	6	10	2	10
100181405	200 x 1 1/2" x 1 1/2"	6	10	2	8
100181406	200 x 2" x 2"	6	10	2	8
100181407	200 x 2 1/2" x 2 1/2"	6	10	2	8
100181408	200 x 3" x 3"	6	6	2	8
100181409	200 x 4" x 4"	6	6	2	6
100181503	225 x 1" x 1"	6	10	2	8
100181504	225 x 1 1/4" x 1 1/4"	6	10	2	8
100181505	225 x 1 1/2" x 1 1/2"	6	10	2	8
100181506	225 x 2" x 2"	6	10	2	8
100181507	225 x 2 1/2" x 2 1/2"	6	10	2	8
100181508	225 x 3" x 3"	6	6	2	8
100181509	225 x 4" x 4"	6	6	2	4



**PRİZ KOLYE ÇİFT ÇIKIŞLI  
PASLANMAZ CIVATALI  
(AISI304)  
PASLANMAZ METAL YÜZÜKLÜ  
(AISI430)**

DOUBLE ENDED CLAMP SADDLE  
WITH STAINLESS STEEL BOLT  
(AISI304)  
STAINLESS STEEL  
REINFORCING RING  
(AISI430)

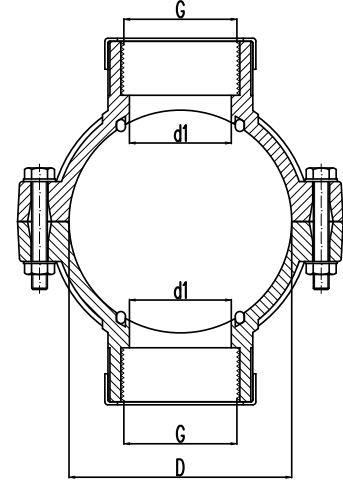

**MANYETİK LOKMA UÇ  
MAGNETIC SOCKET WRENCH**

KOD CODE	EBAT / SIZE	AMBALAJ ADEDİ PACKING QUANTITY
16080	10 mm	5
16083	13 mm	5



# PRİZ KOLYELERİN MONTAJ TALİMATI

INSTALLATION INSTRUCTIONS FOR CLAMP SADDLES

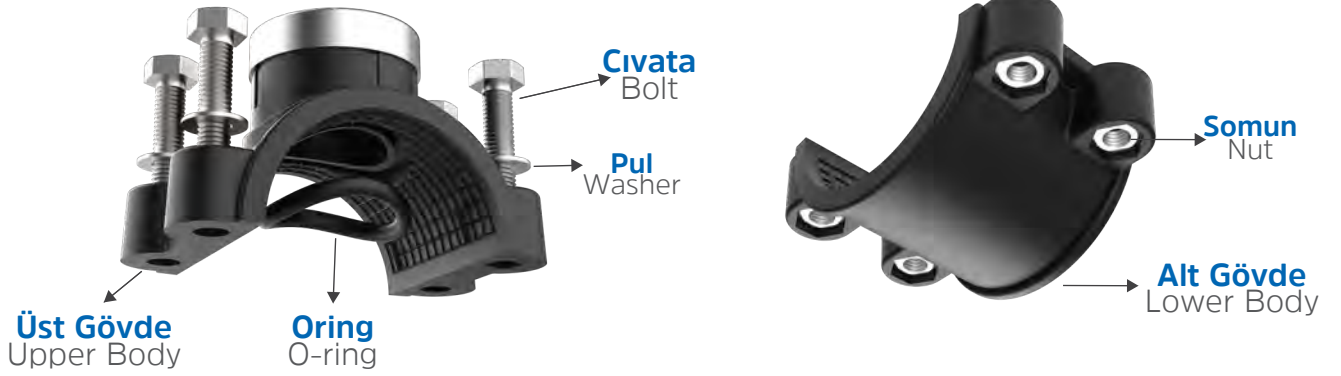

- 1** Borunun çıkış alacağınız noktayı işaretleyiniz.

Mark the point from where you will take off the pipe.



- 2** Priz kolye oringini, üst kapak üzerinde bulunan oring yuvasına düzgün şekilde yerleştiriniz.

Place the O-ring properly into the socket on the upper body.



- 3** Boru üzerinde önce somunları monte edilmiş alt kapağı, sonra üst kapağını boru üzerinde işaretlediğiniz noktaya göre boruya takınız.

First, mount the lower part to the pipe which nuts are inserted on it, then mount the upper part according to the point you marked before on the pipe.



# PRİZ KOLYELERİN MONTAJ TALİMATI

## INSTALLATION INSTRUCTIONS FOR CLAMP SADDLES

- 4 Cıvata ve pulu, manyetik lokma ucuna takınız. Priz kolyelerin çapına uygun tork değerlerine göre matkabınızı ayarlayınız.

Mount the bolt and the washer into the tip of magnetic socket wrench. Adjust the drill according to the appropriate torque values for clamp saddles dimension.

EBAT / SIZE mm	TORK DEĞERLERİ TORQUE VALUES (nm)
Ø25 - Ø50	4,5 Nm
Ø63 - Ø110	6,3 Nm
Ø125 - Ø140	12 Nm
Ø160 - Ø180	13 Nm
Ø200 - Ø225	14 Nm

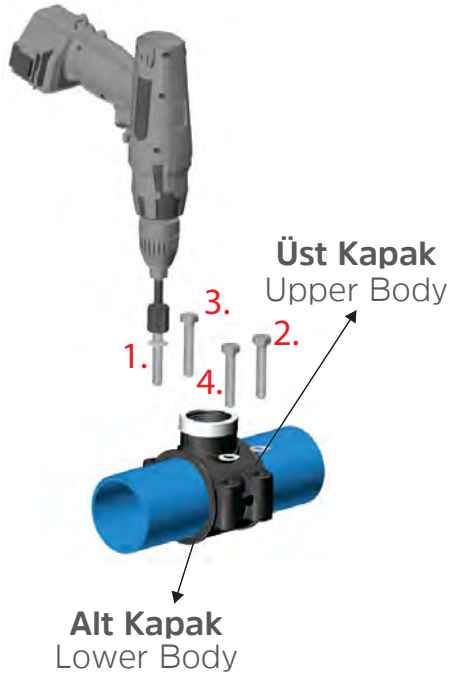
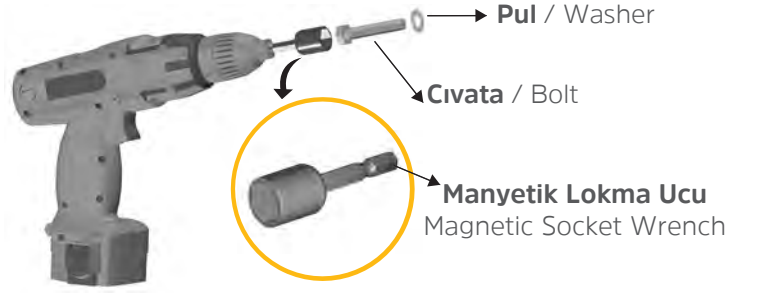

- 5 1. Cıvata ve pulu üst kapak üzerindeki yuvalarına yerleştirerek yarım sıkınız. Sırasıyla, 2. 3. ve 4. cıvataları ve pulları tam sıkınız. Son olarak yarım sıkılan 1. cıvata ve pulu tam sıkınız.

Place the 1st bolt and washer in their housing on the upper part and screw it halfway. Screw completely the 2nd, 3rd and 4th bolts and washers in sequence. Finally completely screw the 1st bolt and washer which are half screwed at the beginning.



- 6 Diş ölçüsüne uygun bir matkap ucu ile ek parçaya değmeyecek şekilde boru delme işlemini gerçekleştiriniz.

Carry out the pipe drilling without touching the saddles with an appropriate drill bit for the thread dimension.

# PRİZ KOLYE

## CLAMP SADDLES

### DİKKAT EDİLMESİ GEREKEN HUSUSLAR

- + Priz Kolyeler depolama ve montaj esnasında sert ve keskin cisimlerden uzak tutulmalıdır. Tesisat toprak altına döşenecekse, sert ve keskin cisimlerden korumak amacıyla kum ile kapatılmalıdır. Hasar görmüş ürünler kesinlikle kullanılmamalıdır.
- + Priz kolyelerde oring, yuvasına düzgünce yerleştirilmeli ve montaj esnasında yerinden çıkmasına özen gösterilmelidir.
- + Priz kolye ile kullanılacak erkek adaptörlere teflon bant sızdırmazlığı sağlayacak kadar ve sıkma yönüyle aynı yönde sarılmalıdır.
- + Priz kolyelerin montajından sonra yapılan boru delme işlemi, uygun bir matkap ucu ile dişlere değmeyecek şekilde gerçekleştirilmelidir.
- + Boruda standart değerinden daha büyük bir ölçüde ise priz kolye montajında alt ve üst kapaklar birbirine değmeyecektir. Bu durumda; cıvatalı priz kolyelerin cıvatalarının alt ve üst kapaklar birbirine değene kadar sıkılmasına gerek yoktur.
- + Priz kolyelerin montajı sırasında cıvata ve somunlar karşılıklı olarak dengeli sıkılmalıdır.

### POINTS TO TAKE INTO CONSIDERATION

- + Clamp saddles should be kept away from hard and sharp objects during the storage and installation. If the installation is laid under the ground, it should be covered with sand to protect it from hard and sharp objects. Any damaged adaptor should not be used absolutely.
- + The o-ring should be placed in its socket properly in order not to be unsettled during the installation.
- + Male adaptors to be used with Clamp Saddles, should be wrapped up with the teflon band with the tightening direction and should be wrapped enough to prevent leakage.
- + Drilling the pipe after the installation of Clamp Saddles can cause the damage of the threads. Thus, drilling must be carried out in a way that it does not touch the threads with a suitable drill bit.
- + If the dimension of the installed pipes is bigger than the standard values upper and lower parts will not contact each other. Under these circumstances, there is no need to tighten the bolts till the upper and lower body parts contact or hammer the slides to the end point.
- + Bolts and nuts must be tightened mutually balanced during installation of the Clamp Saddles.

# PRİZ KOLYE

## CLAMP SADDLES

### Tesisatın Son Kontrolü

#### GÖZLE KONTROL

Tesisatın kurulumu sırasında kullanılan ürünlerin hasar tespiti için mutlaka gözle kontrol yapılmalıdır.

#### SIZDIRMAZLIK KONTROLÜ

Tesisatın kurulumu sonrasında sisteme mutlaka test basıncında su verilmeli ve sızdırmazlık durumu tespit edilmelidir.

#### SIZINTIYA NEDEN OLABİLECEK UYGULAMALAR

- Boru ölçülerinin uluslararası standartlara uygun olmaması,
- Kullanılan diğer metal ya da plastik malzemenin uluslararası standartlara uygun olmaması,
- Teflon bandın yeterli miktarda ve uygun şekilde kullanılmaması,
- Montaj sırasında Priz Kolyenin talimatlara uygun monte edilmemesi,
- Matkap ile boru delme esnasında Priz kolyenin dişlerine zarar verilmesi,
- Montaj esnasında oringin zarar görmesi ya da oringin yerinden çıkması,

tesisatınızda sızıntıya neden olabilir.

### Final Check of the Installation

#### VISUAL CHECK

During installation, the system should be checked visually in order to determine the damaged clamp saddles.

#### LEAKPROOFNESS CHECK

After the installation, the system should be checked with water in testing pressure to determine the water leak.

#### CONDITIONS THAT MAY CAUSE LEAKAGE

- Pipe sizes do not comply with international standards,
- Other metal or plastic materials used do not comply with international standards,
- Not to use the teflon band sufficiently and suitably,
- Incorrect installation of the Clamp Saddles during installation,
- Damage of the threads of the Clamp Saddles during pipe drilling with the drill,
- Damage or displacing of the oring during the installation,

can cause leaking in your installation.

# ISO 13460-1 STANDARDI - TESTLER

## ISO 13460-1 STANDARD - TESTS



### UZUN SÜRELİ İÇ HİDROSTATİK BASINCA DAYANIM TESTİ

Priz Kolyeler, ISO 1167-1 test standardına göre test edilmektedir.

#### RESISTANCE TO LONG-TERM INTERNAL HYDROSTATIC PRESSURE

Clamp Saddles are tested according to the ISO 1167-1 test standard.

MALZEME MATERIAL	PN PN	TEST SICAKLIĞI / (°C) TEST TEMPERATURE / (°C)	TEST SÜRESİ / (SAAT) TEST DURATION / (HOUR)	TEST BASINCI / (BAR) TEST PRESSURE / (BAR)
PP-H	16 BAR	20 95	1 1.000	42.0 7.0
PP-H	10 BAR	20 95	1 1.000	26.8 4.5
PP-H	6 BAR	20 95	1 1.000	12.8 2.8

\* Test Basıncı değerleri, her çap için değişmekte olup, yaklaşık değerlerdir.

\* Test pressure values are variable for each dimensions and are approximate values.



### İÇ HİDROSTATİK BASINCA DAYANIM TESTİ

#### RESISTANCE TO SHORT-TERM INTERNAL HYDROSTATIC PRESSURE

PN PN	TEST SICAKLIĞI / (°C) TEST TEMPERATURE / (°C)	TEST SÜRESİ / (SAAT) TEST DURATION / (HOUR)	TEST BASINCI / (BAR) TEST PRESSURE / (BAR)
16 BAR	20	1	24.0
10 BAR	20	1	15.0
6 BAR	20	1	9.0



### DAİRESEL KAYMA DİRENCİ TESTİ CIRCULAR SLIP RESISTANCE TEST

#### RESISTANCE TO PRESSURE DURING APPLICATION OF A BENDING MOMENT (M= 0,4D) TO THE BRANCH OUTLET

TEST SICAKLIĞI / (°C) TEST TEMPERATURE / (°C)	TEST MOMENTİ / (N.m) TEST MOMENT / (N.m)	TEST SÜRESİ / (DAKİKA) TEST DURATION / (MINUTE)
20 ± 3	0.4 x D	1

**DİŞLER** Priz Kolyeler için dişler, ISO 7-1 standardına uygundur.

**THREADS** Threads for Clamp Saddles are compatible with ISO 7-1 standard.

**SU KALİTESİ ÜZERİNDEKİ ETKİSİ** Ekleme parçaları, içme suyu üzerinde mikroorganizmaların çoğalmalarına izin vermemelidir. KIWA ve TSE kuruluşlarının laboratuvarları tarafından ilgili testler yapılarak raporlandırılmıştır.

**INFLUENCE ON WATER QUALITY** Compression Fittings must not allow increasing microorganism on drinking water. It is reported with the related tests by the laboratories of KIWA and TSE Institutions.

Because the nuts are inserted in their housing on the lower part, it provides quick and easy installation.



Somunlar, alt kapaktaki yuvalarına yerleştirildiği için hızlı ve kolay montaj yapılmasını sağlar.



## PRİZ KOLYE GEÇMELİ CLAMP SADDLES WITH SLIDE

### Özellikler

- + Darbelere karşı dayanıklı, yüksek kaliteli polipropilen hammaddeden üretilmiştir.
- + Borulardaki ölçü farklılıklarından doğabilecek sızıntıları önleyebilecek şekilde tasarlanmıştır.
- + Oringi kauçuktan üretilmekte olup yüksek basınç altında sızdırmazlık sağlar.
- + Suyun kokusunu ve tadını değiştirebilecek zararlı bileşikler içermez.
- + ISO 13460-1 Standardına uygundur.

### KULLANIM ALANLARI

- + Tarımsal Sulama
- + Seralar

**GARANTİ VERİLEN BASINÇ DEĞERİ**  
Ø 25 mm – Ø 110 mm : PN 6

### Specifications

- + It has been produced from high quality polypropylene raw material and **it has resistance to impact**.
- + It is **designed** to prevent leakage caused by the **size differences** of the pipes.
- + O-rings are made of rubber and **provide leakproofness under high pressure**.
- + It does not contain any **harmful compounds** which can change the taste or the smell of the water.
- + It is compatible with **ISO 13460-1 Standard**.

### INSTALLATION AREAS

- + Agricultural Irrigation
- + Greenhouses

**GUARANTEED PRESSURE VALUE**  
Ø 25 mm – Ø 110 mm : PN 6



TS ISO 13460-1



## PRİZ KOLYE GEÇMELİ / CLAMP SADDLES WITH SLIDE

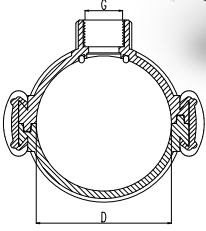

### PRİZ KOLYE GEÇMELİ

CLAMP SADDLE WITH SLIDE

KOD CODE	EBAT / SIZE D x G	BASINÇ DEĞERİ PRESSURE VALUE PN	AMBALAJ ADEDİ PACKING QUANTITY	KOLİ ADEDİ BOX QUANTITY
9311	25 x 1/2"	6	25	300
9321	32 x 1/2"	6	25	250
9322	32 x 3/4"	6	25	250
9331	40 x 1/2"	6	25	200
9332	40 x 3/4"	6	25	200
9341	50 x 1/2"	6	10	90
9342	50 x 3/4"	6	10	100
9343	50 x 1"	6	10	100
9351	63 x 1/2"	6	10	90
9352	63 x 3/4"	6	10	80
9353	63 x 1"	6	10	80
9361	75 x 1/2"	6	5	65
9362	75 x 3/4"	6	5	60
9363	75 x 1"	6	5	70
9371	90 x 1/2"	6	5	60
9372	90 x 3/4"	6	5	45
9373	90 x 1"	6	5	60
9381	110 x 1/2"	6	5	50
9382	110 x 3/4"	6	5	50
9383	110 x 1"	6	5	45

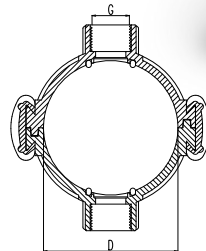

### PRİZ KOLYE ÇİFT ÇIKIŞLI GEÇMELİ

DOUBLE ENDED CLAMP SADDLE WITH SLIDE

KOD CODE	EBAT / SIZE D x G	BASINÇ DEĞERİ PRESSURE VALUE PN	AMBALAJ ADEDİ PACKING QUANTITY	KOLİ ADEDİ BOX QUANTITY
9411	25 x 1/2" x 1/2"	6	25	250
9421	32 x 1/2" x 1/2"	6	25	200
9422	32 x 3/4" x 3/4"	6	25	225
9431	40 x 1/2" x 1/2"	6	25	150
9432	40 x 3/4" x 3/4"	6	25	150
9441	50 x 1/2" x 1/2"	6	10	80
9442	50 x 3/4" x 3/4"	6	10	110
9443	50 x 1" x 1"	6	10	70
9451	63 x 1/2" x 1/2"	6	10	80
9452	63 x 3/4" x 3/4"	6	10	90
9453	63 x 1" x 1"	6	10	70
9461	75 x 1/2" x 1/2"	6	5	60
9462	75 x 3/4" x 3/4"	6	5	50
9463	75 x 1" x 1"	6	5	55
9471	90 x 1/2" x 1/2"	6	5	45
9472	90 x 3/4" x 3/4"	6	5	45
9473	90 x 1" x 1"	6	5	40
9481	110 x 1/2" x 1/2"	6	5	40
9482	110 x 3/4" x 3/4"	6	5	40
9483	110 x 1" x 1"	6	5	40

# PRİZ KOLYE GEÇMELİ

## CLAMP SADDLE WITH SLIDE

### DİKKAT EDİLMESİ GEREKEN HUSUSLAR

- + Priz Kolyeler depolama ve montaj esnasında sert ve keskin cisimlerden uzak tutulmalıdır. Tesisat toprak altına dönecekse, sert ve keskin cisimlerden korumak amacıyla kum ile kapatılmalıdır. Hasar görmüş ürünler kesinlikle kullanılmamalıdır.
- + Priz kolyelerde oring, yuvasına düzgünce yerleştirilmeli ve montaj esnasında yerinden çıkmamasına özen gösterilmelidir.
- + Priz kolye ile kullanılacak erkek adaptörlere teflon bant sızdırmazlığı sağlayacak kadar ve sıkma yönüyle aynı yönde sarılmalıdır.
- + Priz kolyelerin montajından sonra yapılan boru delme işlemi, uygun bir matkap ucu ile dişlere değmeyecek şekilde gerçekleştirilmelidir.
- + Boruda standart değerinden daha büyük bir ölçü farklılığı var ise (> 0.5 mm) priz kolye montajında alt ve üst kapaklar birbirine değmeyecektir. Bu durumda priz kolyenin kamalarının sonuna kadar çakılmasına gerek yoktur.
- + Priz kolyelerin montajı sırasında kamalar karşılıklı monte edilmelidir.

### POINTS TO TAKE INTO CONSIDERATION

- + Clamp saddles should be kept away from hard and sharp objects during the storage and installation. If the installation is laid under the ground, it should be covered with sand to protect it from hard and sharp objects. Any damaged adaptor should not be used absolutely.
- + The o-ring should be placed in its socket properly in order not to be unsettled during the installation.
- + Male adaptors which are going to be used with clamp saddles should be wrapped tight enough to prevent leakage towards fastening direction with a teflon band.
- + Drilling the pipe after the installation of Clamp Saddles can cause the damage of the threads. Thus, drilling must be carried out in a way that it does not touch the threads with a suitable drill bit.
- + If there is a size difference, larger than the standart dimensions (> 0.5 mm) in the pipe, upper and lower body parts will not contact each other during the clamp saddle installation. In this case, there is no need to drive in the wedges of the clamp saddle up to the end.
- + During the installation of the clamp saddles, wedges or bolts should be installed reciprocally.

## LAYFLAT EK PARÇALARI

### LAYFLAT FITTINGS

## Özellikler

- + Darbelere karşı dayanıklı, yüksek kaliteli polipropilen hammaddeden üretilmiştir.
- + Oringi kauçuktan üretilmekte olup yüksek basınç altında sızdırmazlık sağlar.
- + İç yüzeyleri homojen ve gözeneksizdir.
- + Suyun kokusunu ve tadını değiştirebilecek zararlı bileşikler içermez.

## Specifications

- + It has been produced from high quality polypropylene raw material and it has resistance to impact.
- + O-rings are made of rubber and provide leakproofness under high pressure.
- + It has a homogeneous and non-porous inner surface.
- + It does not contain any harmful compounds which can change the taste or the smell of the water.

### GARANTİ VERİLEN BASINÇ DEĞERLERİ GUARANTEED PRESSURE VALUES

2" - 2 ½"	: PN 10
3" - 4" - 5"	: PN 6
6"	: PN 4

### KULLANIM ALANLARI

- + Tarımsal Sulama Sistemleri
- + Damla Sulama Sistemleri
- + Yağmurlama Sulama Sistemleri
- + Drenaj Sistemleri
- + Açık Alan Sulama Sistemleri
- + Madencilik Sektörü
- + İnşaat Sektörü

### INSTALLATION AREAS

- + Agricultural Irrigation Systems
- + Drip Irrigation Systems
- + Sprinkler Irrigation Systems
- + Drainage Systems
- + Open Field Irrigation Systems
- + Mining Sector
- + Construction Sector

ÖLÇÜ SIZE	LAYFLAT BORU İÇ ÇAPI LAYFLAT PIPE INTERNAL DIAMETER
2"	52 mm
2 ½"	65 mm
3"	77 mm
4"	103 mm
5"	128 mm
6"	153 mm



## LAYFLAT EK PARÇALARI / LAYFLAT FITTINGS

KOD CODE	EBAT / SIZE d x G	BASINÇ DEĞERİ PRESSURE VALUE PN	AMBALAJ ADEDİ PACKING QUANTITY	KOLİ ADEDİ BOX QUANTITY
<b>71155</b>	<b>2" x 2"</b>	<b>10</b>	<b>10</b>	<b>70</b>
71165	2 1/2" x 2"	10	6	48
<b>71166</b>	<b>2 1/2" x 2 1/2"</b>	<b>10</b>	<b>6</b>	<b>48</b>
71177	3" x 3"	6	4	28
<b>71187</b>	<b>4" x 3"</b>	<b>6</b>	<b>4</b>	<b>16</b>
71188	4" x 4"	6	4	12
<b>71198</b>	<b>5" x 4"</b>	<b>6</b>	<b>2</b>	<b>10</b>
71199	5" x 5"	6	2	10
<b>7119908</b>	<b>6" x 4"</b>	<b>4</b>	<b>2</b>	<b>4</b>
7119909	6" x 5"	4	2	4

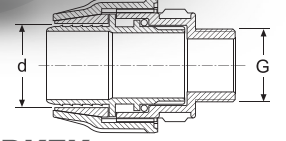

**LAYFLAT ERKEK**  
LAYFLAT MALE ADAPTOR

KOD CODE	EBAT / SIZE d x G	BASINÇ DEĞERİ PRESSURE VALUE PN	AMBALAJ ADEDİ PACKING QUANTITY	KOLİ ADEDİ BOX QUANTITY
<b>71255</b>	<b>2" x 2"</b>	<b>10</b>	<b>10</b>	<b>70</b>
71266	2 1/2" x 2 1/2"	10	6	42
<b>71277</b>	<b>3" x 3"</b>	<b>6</b>	<b>4</b>	<b>28</b>
71288	4" x 4"	6	4	12
<b>71298</b>	<b>5" x 4"</b>	<b>6</b>	<b>2</b>	<b>12</b>
71299	5" x 5"	6	2	8
<b>7129909</b>	<b>6" x 5"</b>	<b>4</b>	<b>2</b>	<b>4</b>

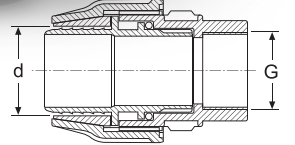

**LAYFLAT Dişi**  
LAYFLAT FEMALE ADAPTOR

KOD CODE	EBAT / SIZE d x d	BASINÇ DEĞERİ PRESSURE VALUE PN	AMBALAJ ADEDİ PACKING QUANTITY	KOLİ ADEDİ BOX QUANTITY
<b>71355</b>	<b>2" x 2"</b>	<b>10</b>	<b>6</b>	<b>42</b>
71366	2 1/2" x 2 1/2"	10	5	25
<b>71377</b>	<b>3" x 3"</b>	<b>6</b>	<b>2</b>	<b>16</b>
71388	4" x 4"	6	2	8
<b>71399</b>	<b>5" x 5"</b>	<b>6</b>	<b>1</b>	<b>6</b>
7139910	6" x 6"	4	1	2

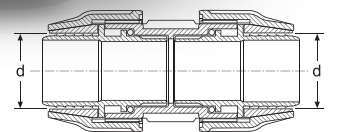

**LAYFLAT MANŞON**  
LAYFLAT COUPLING



## LAYFLAT EK PARÇALARI / LAYFLAT FITTINGS

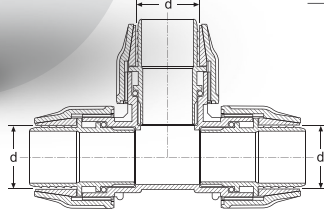

**LAYFLAT TE**  
LAYFLAT TEE

KOD CODE	EBAT / SIZE d x d x d	BASINÇ DEĞERİ PRESSURE VALUE PN	AMBALAJ ADEDİ PACKING QUANTITY	KOLİ ADEDİ BOX QUANTITY
71455	2" x 2" x 2"	10	4	28
71466	2 1/2" x 2 1/2" x 2 1/2"	10	3	15
71477	3" x 3" x 3"	6	1	10
71488	4" x 4" x 4"	6	1	4
71499	5" x 5" x 5"	6	1	2
7149910	6" x 6" x 6"	4	1	1

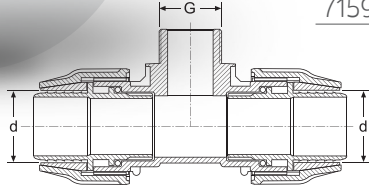

**LAYFLAT ERKEK TE**  
LAYFLAT MALE TEE

KOD CODE	EBAT / SIZE d x G x d	BASINÇ DEĞERİ PRESSURE VALUE PN	AMBALAJ ADEDİ PACKING QUANTITY	KOLİ ADEDİ BOX QUANTITY
71555	2" x 2" x 2"	10	4	32
71566	2 1/2" x 2 1/2" x 2 1/2"	10	3	15
71577	3" x 3" x 3"	6	1	12
71588	4" x 4" x 4"	6	1	6
71598	5" x 4" x 5"	6	1	4
71599	5" x 5" x 5"	6	1	4
7159908	6" x 4" x 6"	4	1	2
7159909	6" x 5" x 6"	4	1	2

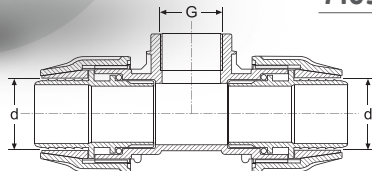

**LAYFLAT DİŞİ TE**  
LAYFLAT FEMALE TEE

KOD CODE	EBAT / SIZE d x G x d	BASINÇ DEĞERİ PRESSURE VALUE PN	AMBALAJ ADEDİ PACKING QUANTITY	KOLİ ADEDİ BOX QUANTITY
71655	2" x 2" x 2"	10	4	24
71666	2 1/2" x 2 1/2" x 2 1/2"	10	3	15
71677	3" x 3" x 3"	6	1	12
71688	4" x 4" x 4"	6	1	5
71698	5" x 4" x 5"	6	1	4
71699	5" x 5" x 5"	6	1	3
7169909	6" x 5" x 6"	4	1	2

## LAYFLAT EK PARÇALARI / LAYFLAT FITTINGS

KOD CODE	EBAT / SIZE d x d	BASINÇ DEĞERİ PRESSURE VALUE PN	AMBALAJ ADEDİ PACKING QUANTITY	KOLİ ADEDİ BOX QUANTITY
<b>71755</b>	<b>2" x 2"</b>	<b>10</b>	<b>4</b>	<b>40</b>
71766	2 1/2" x 2 1/2"	10	4	20
<b>71777</b>	<b>3" x 3"</b>	<b>6</b>	<b>2</b>	<b>14</b>
71788	4" x 4"	6	1	7
<b>71799</b>	<b>5" x 5"</b>	<b>6</b>	<b>1</b>	<b>4</b>
7179910	6" x 6"	4	1	2

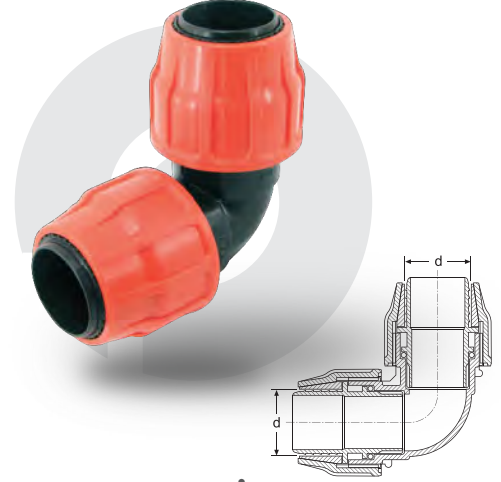

**LAYFLAT DİRSEK**  
LAYFLAT ELBOW

KOD CODE	EBAT / SIZE d x G	BASINÇ DEĞERİ PRESSURE VALUE PN	AMBALAJ ADEDİ PACKING QUANTITY	KOLİ ADEDİ BOX QUANTITY
<b>71855</b>	<b>2" x 2"</b>	<b>10</b>	<b>4</b>	<b>56</b>
71866	2 1/2" x 2 1/2"	10	4	36
<b>71877</b>	<b>3" x 3"</b>	<b>6</b>	<b>2</b>	<b>18</b>
71888	4" x 4"	6	1	11
<b>71898</b>	<b>5" x 4"</b>	<b>6</b>	<b>1</b>	<b>8</b>
71899	5" x 5"	6	1	6
<b>7189909</b>	<b>6" x 5"</b>	<b>4</b>	<b>1</b>	<b>4</b>

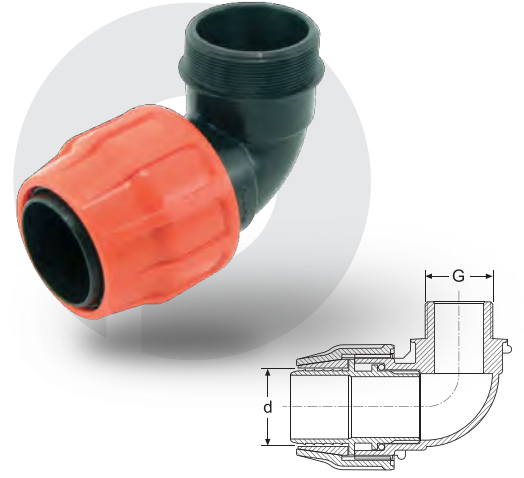

**LAYFLAT ERKEK DİRSEK**  
LAYFLAT MALE ELBOW

KOD CODE	EBAT / SIZE d x G	BASINÇ DEĞERİ PRESSURE VALUE PN	AMBALAJ ADEDİ PACKING QUANTITY	KOLİ ADEDİ BOX QUANTITY
<b>71955</b>	<b>2" x 2"</b>	<b>10</b>	<b>4</b>	<b>48</b>
71966	2 1/2" x 2 1/2"	10	4	32
<b>71977</b>	<b>3" x 3"</b>	<b>6</b>	<b>2</b>	<b>20</b>
71988	4" x 4"	6	1	11
<b>71998</b>	<b>5" x 4"</b>	<b>6</b>	<b>1</b>	<b>6</b>
71999	5" x 5"	6	1	6
<b>7199909</b>	<b>6" x 5"</b>	<b>4</b>	<b>1</b>	<b>4</b>

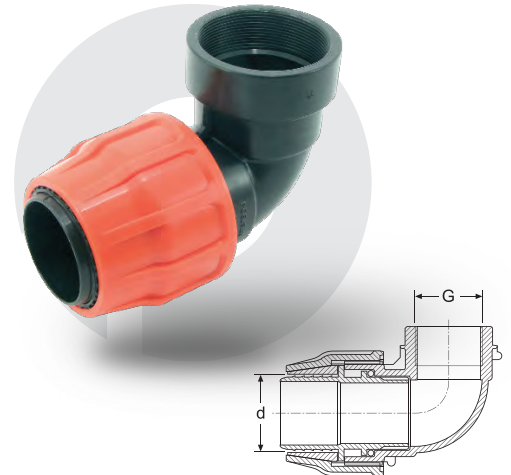

**LAYFLAT DIŞİ DİRSEK**  
LAYFLAT FEMALE ELBOW

## LAYFLAT EK PARÇALARI / LAYFLAT FITTINGS

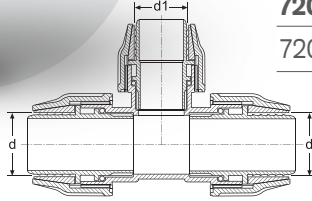

**LAYFLAT REDÜKSİYON TE**  
LAYFLAT REDUCING TEE

KOD CODE	EBAT / SIZE d x d <sub>1</sub> x d <sub>2</sub>	BASINÇ DEĞERİ PRESSURE VALUE PN	AMBALAJ ADEDİ PACKING QUANTITY	KOLİ ADEDİ BOX QUANTITY
<b>72065</b>	<b>2 1/2" x 2" x 2 1/2"</b>	<b>10</b>	<b>3</b>	<b>15</b>
72076	3" x 2 1/2" x 3"	6	1	11
<b>72087</b>	<b>4" x 3" x 4"</b>	<b>6</b>	<b>1</b>	<b>6</b>
72098	5" x 4" x 5"	6	1	2
<b>7209908</b>	<b>6" x 4" x 6"</b>	<b>4</b>	<b>1</b>	<b>2</b>
7209909	6" x 5" x 6"	4	1	2

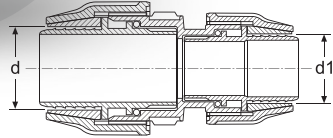

**LAYFLAT REDÜKSİYON MANŞON**  
LAYFLAT REDUCING COUPLING

KOD CODE	EBAT / SIZE d x d <sub>1</sub>	BASINÇ DEĞERİ PRESSURE VALUE PN	AMBALAJ ADEDİ PACKING QUANTITY	KOLİ ADEDİ BOX QUANTITY
<b>72165</b>	<b>2 1/2" x 2"</b>	<b>10</b>	<b>6</b>	<b>30</b>
72176	3" x 2 1/2"	6	2	18
<b>72187</b>	<b>4" x 3"</b>	<b>6</b>	<b>2</b>	<b>10</b>
72198	5" x 4"	6	1	6
<b>7219908</b>	<b>6" x 4"</b>	<b>4</b>	<b>1</b>	<b>6</b>
7219909	6" x 5"	4	1	4

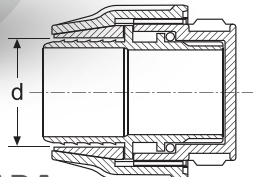

**LAYFLAT KÖR TAPA**  
LAYFLAT END CAP

KOD CODE	EBAT / SIZE d	BASINÇ DEĞERİ PRESSURE VALUE PN	AMBALAJ ADEDİ PACKING QUANTITY	KOLİ ADEDİ BOX QUANTITY
<b>72255</b>	<b>2"</b>	<b>10</b>	<b>12</b>	<b>84</b>
72266	2 1/2"	10	6	54
<b>72277</b>	<b>3"</b>	<b>6</b>	<b>4</b>	<b>32</b>
72288	4"	6	4	16
<b>72299</b>	<b>5"</b>	<b>6</b>	<b>2</b>	<b>12</b>
7229910	6"	4	2	4

# LAYFLAT ÇIKIŞ NİPELLERİ / LAYFLAT OFFTAKE NIPPLES

## LAYFLAT DİŞLİ ÇIKIŞ NİPELİ

LAYFLAT THREADED OFFTAKE NIPPLE

KOD CODE	G SIZE-mm	AMBALAJ ADEDİ PACKING QUANTITY	KOLİ ADEDİ BOX QUANTITY
72500	1/2"	50	900
72501	3/4"	50	800

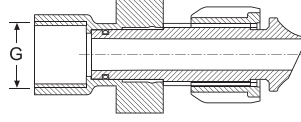

## LAYFLAT KURTAĞZI ÇIKIŞ NİPELİ

LAYFLAT BARBED OFFTAKE NIPPLE

KOD CODE	G SIZE-mm	AMBALAJ ADEDİ PACKING QUANTITY	KOLİ ADEDİ BOX QUANTITY
72511	16	50	1000
72512	20	50	900

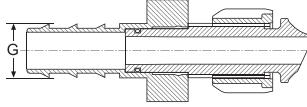

## LAYFLAT YASSI DAMLAMA ÇIKIŞ NİPELİ

LAYFLAT TAPE OFFTAKE NIPPLE

KOD CODE	G SIZE-mm	AMBALAJ ADEDİ PACKING QUANTITY	KOLİ ADEDİ BOX QUANTITY
72531	17	50	900
72532	22	50	600

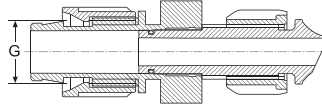

## LAYFLAT YÜZÜKLÜ YASSI DAMLAMA ÇIKIŞ NİPELİ

LAYFLAT TAPE (WITH RING) OFFTAKE NIPPLE

KOD CODE	G SIZE-mm	AMBALAJ ADEDİ PACKING QUANTITY	KOLİ ADEDİ BOX QUANTITY
72541	17	50	1000

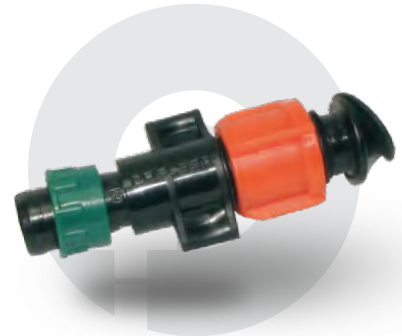
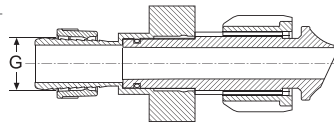

## KABLİN ANAHTARI

FITTING SPANNER

KOD CODE	EBAT SIZE-mm	GÖVDE EBADI BODY SIZE	AMBALAJ ADEDİ PACKING QUANTITY	KOLİ ADEDİ BOX QUANTITY
4936	32 - 63	2" - 2 1/2"	5	140
4969	63 - 110	3" - 4" - 5"	5	45
49699	125	6"	2	24



# LAYFLAT EK PARÇALARI & ÇIKIŞ NİPELLERİ

## LAYFLAT FITTINGS & OFFTAKE NIPPLES

### DİKKAT EDİLMESİ GEREKEN HUSUSLAR

- + Layflat Çıkış Nipelleri ile çıkış almak için delik çapı 13 mm olacak şekilde boru delinmelidir.
- + Layflat Ek Parçalarının boruya montajı sırasında Layflat Boru katlama noktasının dış boru tutucu üzerindeki açık kanallara denk gelmemesine dikkat edilmelidir.

### POINTS TO TAKE INTO CONSIDERATION

- + To get offtake with Layflat Offtake Nipple, the pipe should be drilled according to the hole diameter to be 13 mm.
- + During the assembling of Layflat Fittings, it should be avoided to Layflat Pipe folding point to come up to the opened channels on the outer pipe holder.



# DİŞLİ BAĞLANTI ELEMANLARI

## THREADED FITTINGS

### Özellikler

- + Darbelere karşı dayanıklı, yüksek kaliteli polipropilen hammaddeden üretilmiştir.
- + UV ışınlarını geçirmediği için yosunlanmaya ve bakteri üremesine izin vermez.
- + İç yüzeyleri homojen ve gözeneksizdir.
- + Suyun kokusunu ve tadını değiştirebilecek zararlı bileşikler içermez.

### MTT-100 Kollektör Te Özellikleri

- + BSP dişli vanalar ve vana manifoldu kurmak için kullanılır.
- + Kurulum için araç gerektirmez.
- + Kendinden o-ringlidir, kollektörler arasında sızdırmazlık sağlar.

**GARANTİ VERİLEN BASINÇ DEĞERİ : PN 10**  
**GUARANTEED PRESSURE VALUE : PN 10**

### KULLANIM ALANLARI

- + Peyzaj Sektörü
- + Tarımsal Sulama

### INSTALLATION AREAS

- + Landscaping Systems
- + Agricultural Irrigation

### Specifications

- + It has been produced from high quality polypropylene raw material and it has resistance to impact.
- + They prevent alga and bacteria forming due to UV proof (ultraviolet beam) structure.
- + It has a homogeneous and non-porous inner surface.
- + It does not contain any harmful compounds which can change the taste or the smell of the water.

### MTT-100 Kollektör Tee Specifications

- + BSP Thread is used to install female valves, and valve manifold.
- + It does not require tools for installation.
- + It has self a o-ring providing leakproofness between collectors.



## DIŞLİ BAĞLANTI ELEMANLARI / THREADED FITTINGS

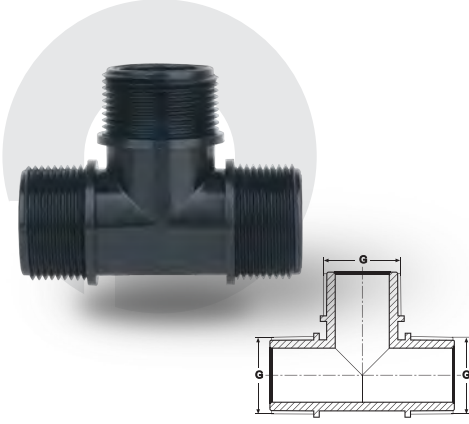

**DIŞLİ TE ERKEK - ERKEK - ERKEK**  
THREADED TEE MALE - MALE - MALE

KOD CODE	EBAT / SIZE G x G x G	BASINÇ DEĞERİ PRESSURE VALUE PN	AMBALAJ ADEDİ PACKING QUANTITY	KOLİ ADEDİ BOX QUANTITY
13111	1/2" x 1/2" x 1/2"	10	25	800
13112	1/2" x 3/4" x 1/2"	10	25	600
13121	3/4" x 1/2" x 3/4"	10	25	600
13122	3/4" x 3/4" x 3/4"	10	25	600
13123	3/4" x 1" x 3/4"	10	25	550
13131	1" x 1/2" x 1"	10	25	400
13132	1" x 3/4" x 1"	10	25	400
13133	1" x 1" x 1"	10	25	400
13141	1 1/4" x 1/2" x 1 1/4"	10	15	210
13142	1 1/4" x 3/4" x 1 1/4"	10	15	210
13143	1 1/4" x 1" x 1 1/4"	10	15	210
13144	1 1/4" x 1 1/4" x 1 1/4"	10	15	180
13155	1 1/2" x 1 1/2" x 1 1/2"	10	10	100
13165	2" x 1 1/2" x 2"	10	6	66
13166	2" x 2" x 2"	10	6	60
13177	2 1/2" x 2 1/2" x 2 1/2"	10	3	36
13188	3" x 3" x 3"	10	2	22
13199	4" x 4" x 4"	10	1	15

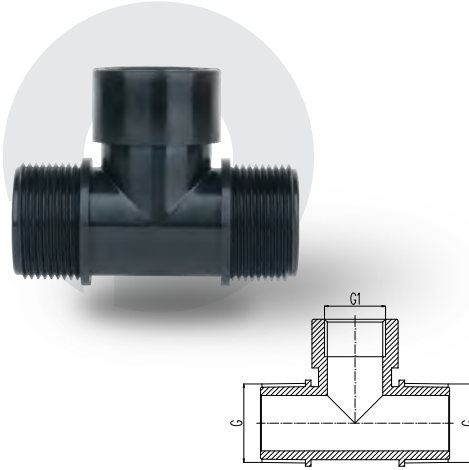

**DIŞLİ TE ERKEK - DIŞİ - ERKEK**  
THREADED TEE MALE - FEMALE - MALE

KOD CODE	EBAT / SIZE G x G x G	BASINÇ DEĞERİ PRESSURE VALUE PN	AMBALAJ ADEDİ PACKING QUANTITY	KOLİ ADEDİ BOX QUANTITY
13211	1/2" x 1/2" x 1/2"	10	25	550
13212	1/2" x 3/4" x 1/2"	10	25	500
13221	3/4" x 1/2" x 3/4"	10	25	500
13222	3/4" x 3/4" x 3/4"	10	25	450
13223	3/4" x 1" x 3/4"	10	25	375
13231	1" x 1/2" x 1"	10	25	400
13232	1" x 3/4" x 1"	10	25	350
13233	1" x 1" x 1"	10	25	300
13242	1 1/4" x 3/4" x 1 1/4"	10	15	195
13243	1 1/4" x 1" x 1 1/4"	10	15	180
13254	1 1/2" x 1 1/4" x 1 1/2"	10	10	110
13255	1 1/2" x 1 1/2" x 1 1/2"	10	10	80
13264	2" x 1 1/4" x 2"	10	6	60
13265	2" x 1 1/2" x 2"	10	6	60
13266	2" x 2" x 2"	10	6	48
13267	2 1/2" x 2 1/2" x 2 1/2"	10	3	30
13268	3" x 3" x 3"	10	2	18
13269	4" x 4" x 4"	10	1	14

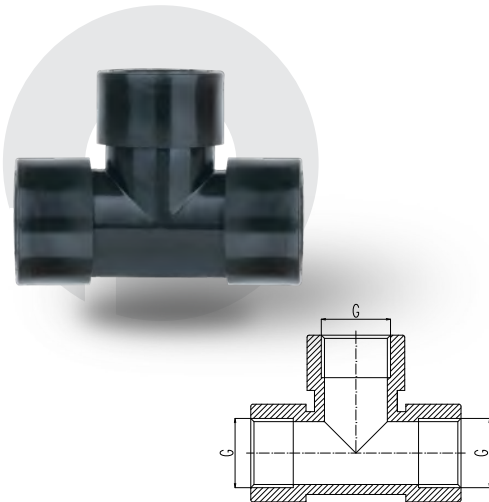

**DIŞLİ TE DIŞİ - DIŞİ - DIŞİ**  
THREADED TEE FEMALE - FEMALE - FEMALE

KOD CODE	EBAT / SIZE G x G x G	BASINÇ DEĞERİ PRESSURE VALUE PN	AMBALAJ ADEDİ PACKING QUANTITY	KOLİ ADEDİ BOX QUANTITY
13271	1/2" x 1/2" x 1/2"	10	25	450
13272	3/4" x 3/4" x 3/4"	10	25	275
13273	1" x 1" x 1"	10	25	200
13274	1 1/4" x 1 1/4" x 1 1/4"	10	15	105
13275	1 1/2" x 1 1/2" x 1 1/2"	10	10	60
13276	2" x 2" x 2"	10	6	42
13277	2 1/2" x 2 1/2" x 2 1/2"	10	3	27
13278	3" x 3" x 3"	10	2	18
13279	4" x 4" x 4"	10	1	12

## DİŞLİ BAĞLANTI ELEMANLARI / THREADED FITTINGS

KOD CODE	EBAT / SIZE G x G	BASINÇ DEĞERİ PRESSURE VALUE PN	AMBALAJ ADEDİ PACKING QUANTITY	KOLİ ADEDİ BOX QUANTITY
13311	1/2" x 1/2"	10	25	900
13321	3/4" x 1/2"	10	25	950
13322	3/4" x 3/4"	10	25	900
13331	1" x 1/2"	10	25	600
13332	1" x 3/4"	10	25	600
13333	1" x 1"	10	25	550
13341	1 1/4" x 1/2"	10	15	300
13342	1 1/4" x 3/4"	10	15	300
13343	1 1/4" x 1"	10	15	300
13344	1 1/4" x 1 1/4"	10	15	240
13355	1 1/2" x 1 1/2"	10	10	150
13364	2" x 1 1/4"	10	6	108
13365	2" x 1 1/2"	10	6	108
13366	2" x 2"	10	6	90
13377	2 1/2" x 2 1/2"	10	4	56
13388	3" x 3"	10	2	36
13399	4" x 4"	10	1	23

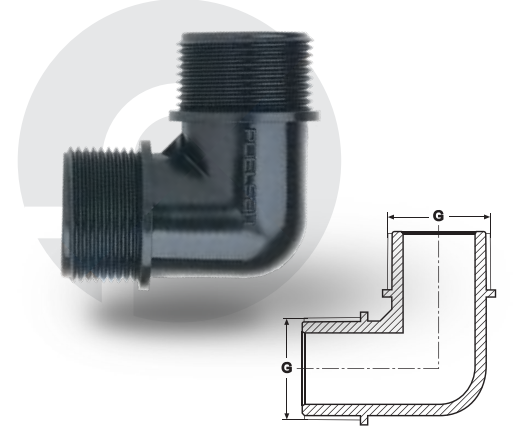

**DİŞLİ DİRSEK ERKEK - ERKEK**  
THREADED ELBOW MALE - MALE

KOD CODE	EBAT / SIZE G x G <sub>1</sub>	BASINÇ DEĞERİ PRESSURE VALUE PN	AMBALAJ ADEDİ PACKING QUANTITY	KOLİ ADEDİ BOX QUANTITY
13411	1/2" x 1/2"	10	25	800
13412	1/2" x 3/4"	10	25	600
13421	3/4" x 1/2"	10	25	700
13422	3/4" x 3/4"	10	25	600
13423	3/4" x 1"	10	25	500
13431	1" x 1/2"	10	25	550
13432	1" x 3/4"	10	25	500
13433	1" x 1"	10	25	400
13442	1 1/4" x 3/4"	10	15	270
13443	1 1/4" x 1"	10	15	240
13444	1 1/4" x 1 1/4"	10	15	210
13454	1 1/2" x 1 1/4"	10	10	140
13455	1 1/2" x 1 1/2"	10	10	120
13464	2" x 1 1/4"	10	6	108
13465	2" x 1 1/2"	10	6	84
13466	2" x 2"	10	6	72
13467	2 1/2" x 2 1/2"	10	4	48
13468	3" x 3"	10	2	32
13469	4" x 4"	10	1	18

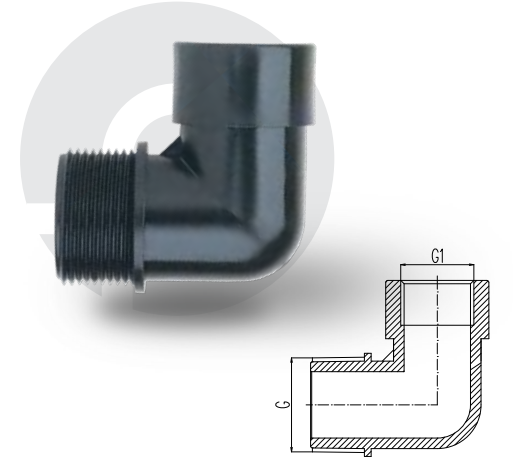

**DİŞLİ DİRSEK ERKEK - DİŞİ**  
THREADED ELBOW MALE - FEMALE

KOD CODE	EBAT / SIZE G x G	BASINÇ DEĞERİ PRESSURE VALUE PN	AMBALAJ ADEDİ PACKING QUANTITY	KOLİ ADEDİ BOX QUANTITY
13471	1/2" x 1/2"	10	25	800
13472	3/4" x 3/4"	10	25	450
13473	1" x 1"	10	25	300
13474	1 1/4" x 1 1/4"	10	15	180
13475	1 1/2" x 1 1/2"	10	10	110
13476	2" x 2"	10	6	66
13477	2 1/2" x 2 1/2"	10	4	36
13478	3" x 3"	10	2	26
13479	4" x 4"	10	1	16
13480	1 1/2" x 1 1/4"	10	10	120

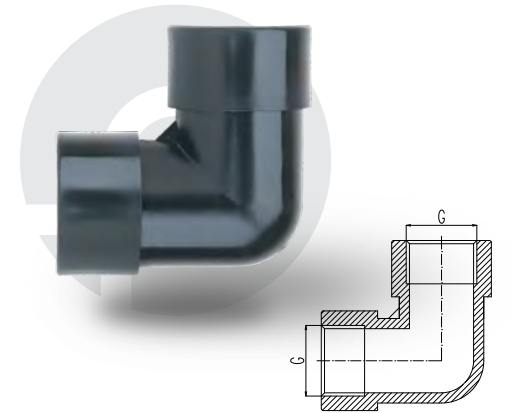

**DİŞLİ DİRSEK DİŞİ - DİŞİ**  
THREADED ELBOW FEMALE - FEMALE

# DİŞLİ BAĞLANTI ELEMANLARI / THREADED FITTINGS

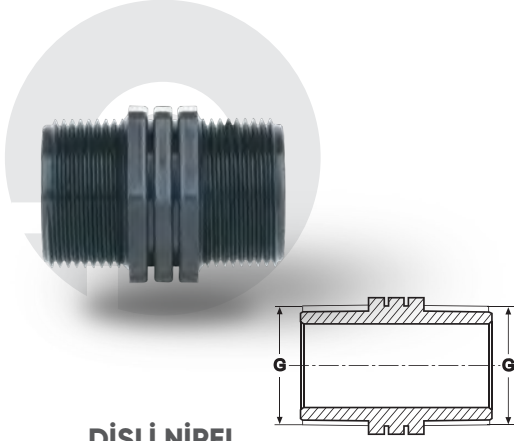

**DİŞLİ NİPEL**  
THREADED NIPPLE

KOD CODE	EBAT / SIZE G x G	BASINÇ DEĞERİ PRESSURE VALUE PN	AMBALAJ ADEDİ PACKING QUANTITY	KOLİ ADEDİ BOX QUANTITY
<b>13500</b>	<b>1/4" x 1/4"</b>	<b>10</b>	<b>100</b>	<b>7000</b>
13511	1/2" x 1/2"	10	50	1500
<b>13522</b>	<b>3/4" x 3/4"</b>	<b>10</b>	<b>50</b>	<b>1400</b>
13533	1" x 1"	10	50	800
<b>13544</b>	<b>1 1/4" x 1 1/4"</b>	<b>10</b>	<b>25</b>	<b>375</b>
13555	1 1/2" x 1 1/2"	10	25	250
<b>13566</b>	<b>2" x 2"</b>	<b>10</b>	<b>25</b>	<b>150</b>
13577	2 1/2" x 2 1/2"	10	12	96
<b>13588</b>	<b>3" x 3"</b>	<b>10</b>	<b>12</b>	<b>60</b>
13599	4" x 4"	10	6	36

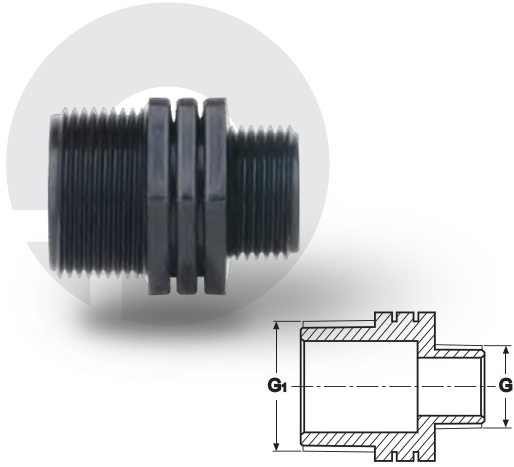

**DİŞLİ REDÜKSİYON NİPEL**  
THREADED REDUCING NIPPLE

KOD CODE	EBAT / SIZE G x G	BASINÇ DEĞERİ PRESSURE VALUE PN	AMBALAJ ADEDİ PACKING QUANTITY	KOLİ ADEDİ BOX QUANTITY
<b>13621</b>	<b>3/4" x 1/2"</b>	<b>10</b>	<b>50</b>	<b>1500</b>
13631	1" x 1/2"	10	50	1000
<b>13632</b>	<b>1" x 3/4"</b>	<b>10</b>	<b>50</b>	<b>1000</b>
13641	1 1/4" x 1/2"	10	25	450
<b>13642</b>	<b>1 1/4" x 3/4"</b>	<b>10</b>	<b>25</b>	<b>450</b>
13643	1 1/4" x 1"	10	25	450
<b>13652</b>	<b>1 1/2" x 3/4"</b>	<b>10</b>	<b>25</b>	<b>300</b>
13653	1 1/2" x 1"	10	25	300
<b>13654</b>	<b>1 1/2" x 1 1/4"</b>	<b>10</b>	<b>25</b>	<b>250</b>
13663	2" x 1"	10	25	200
<b>13664</b>	<b>2" x 1 1/4"</b>	<b>10</b>	<b>25</b>	<b>175</b>
13665	2" x 1 1/2"	10	25	175
<b>13674</b>	<b>2 1/2" x 1 1/4"</b>	<b>10</b>	<b>12</b>	<b>120</b>
13675	2 1/2" x 1 1/2"	10	12	108
<b>13676</b>	<b>2 1/2" x 2"</b>	<b>10</b>	<b>12</b>	<b>108</b>
13685	3" x 1 1/2"	10	12	96
<b>13686</b>	<b>3" x 2"</b>	<b>10</b>	<b>12</b>	<b>96</b>
13687	3" x 2 1/2"	10	12	72
<b>13696</b>	<b>4" x 2"</b>	<b>10</b>	<b>6</b>	<b>60</b>
13697	4" x 2 1/2"	10	6	54
<b>13698</b>	<b>4" x 3"</b>	<b>10</b>	<b>6</b>	<b>54</b>

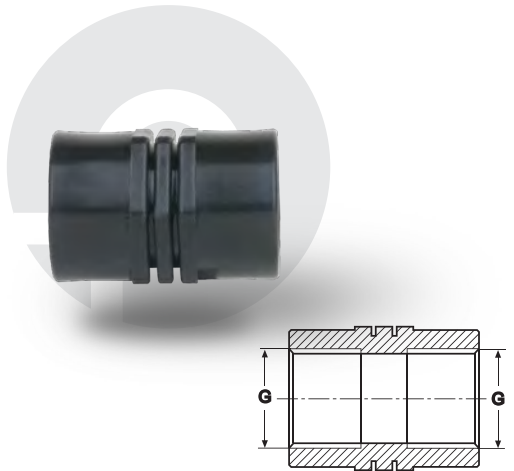

**DİŞLİ MANŞON**  
THREADED COUPLING

KOD CODE	EBAT / SIZE G x G	BASINÇ DEĞERİ PRESSURE VALUE PN	AMBALAJ ADEDİ PACKING QUANTITY	KOLİ ADEDİ BOX QUANTITY
<b>13711</b>	<b>1/2" x 1/2"</b>	<b>10</b>	<b>50</b>	<b>1400</b>
13722	3/4" x 3/4"	10	50	900
<b>13733</b>	<b>1" x 1"</b>	<b>10</b>	<b>50</b>	<b>500</b>
13744	1 1/4" x 1 1/4"	10	25	250
<b>13755</b>	<b>1 1/2" x 1 1/2"</b>	<b>10</b>	<b>15</b>	<b>225</b>
13766	2" x 2"	10	12	144
<b>13777</b>	<b>2 1/2" x 2 1/2"</b>	<b>10</b>	<b>12</b>	<b>120</b>
13788	3" x 3"	10	6	60
<b>13799</b>	<b>4" x 4"</b>	<b>10</b>	<b>4</b>	<b>40</b>

## DİŞLİ BAĞLANTI ELEMANLARI / THREADED FITTINGS

KOD CODE	EBAT / SIZE G <sub>1</sub> x G	BASINÇ DEĞERİ PRESSURE VALUE PN	AMBALAJ ADEDİ PACKING QUANTITY	KOLİ ADEDİ BOX QUANTITY
13821	¾" x ½"	10	50	1000
13831	1" x ½"	10	50	650
13832	1" x ¾"	10	50	600
13842	1 ¼" x ¾"	10	25	300
13843	1 ¼" x 1"	10	25	275
13853	1 ½" x 1"	10	15	270
13854	1 ½" x 1 ¼"	10	15	240
13864	2" x 1 ¼"	10	12	192
13865	2" x 1 ½"	10	12	168
13874	2 ½" x 1 ¼"	10	12	168
13875	2 ½" x 1 ½"	10	12	168
13876	2 ½" x 2"	10	12	120
13886	3" x 2"	10	6	84
13887	3" x 2 ½"	10	6	72
13896	4" x 2"	10	4	56
13897	4" x 2 ½"	10	4	48
13898	4" x 3"	10	4	48

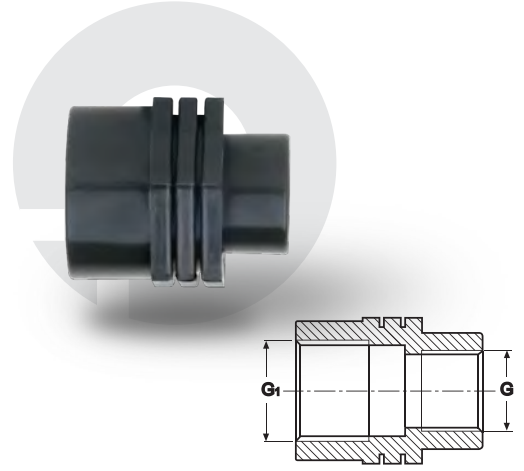

**DİŞLİ REDÜKSİYON MANŞON**  
THREADED REDUCING COUPLING

KOD CODE	EBAT / SIZE G	BASINÇ DEĞERİ PRESSURE VALUE PN	AMBALAJ ADEDİ PACKING QUANTITY	KOLİ ADEDİ BOX QUANTITY
14111	½"	10	50	2000
14122	¾"	10	50	1800
14133	1"	10	50	1200
14144	1 ¼"	10	25	550
14155	1 ½"	10	15	360
14166	2"	10	12	240
14177	2 ½"	10	12	144
14188	3"	10	6	108
14199	4"	10	4	56

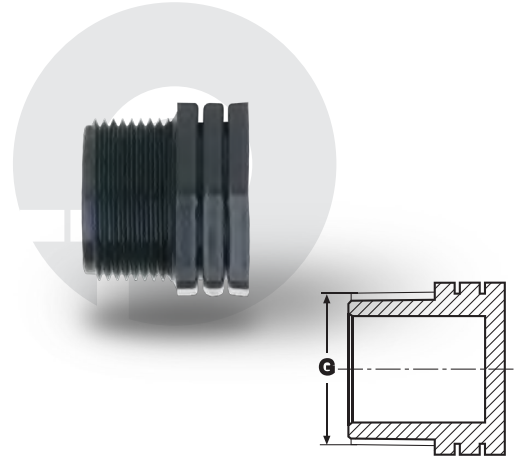

**DİŞLİ KÖR TAPA ERKEK**  
THREADED END CAP MALE

KOD CODE	EBAT / SIZE G	BASINÇ DEĞERİ PRESSURE VALUE PN	AMBALAJ ADEDİ PACKING QUANTITY	KOLİ ADEDİ BOX QUANTITY
14211	½"	10	50	2200
14222	¾"	10	50	1250
14233	1"	10	50	600

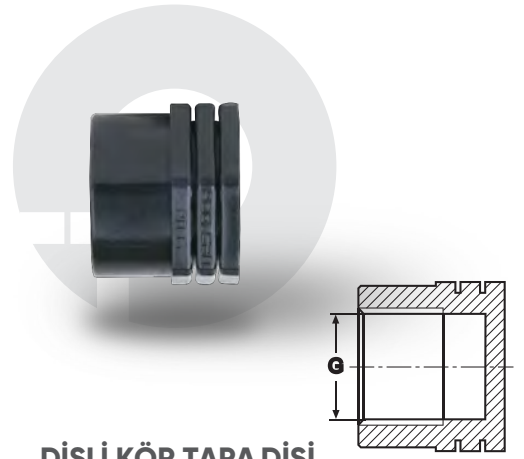

**DİŞLİ KÖR TAPA DIŞI**  
THREADED END CAP FEMALE



# DIŞLİ BAĞLANTI ELEMANLARI / THREADED FITTINGS



**DIŞLİ REDÜKSİYON ERKEK - DIŞİ**  
THREADED REDUCING MALE - FEMALE

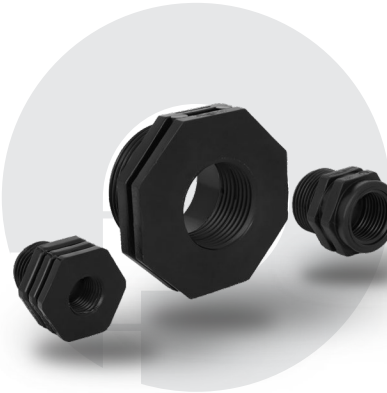
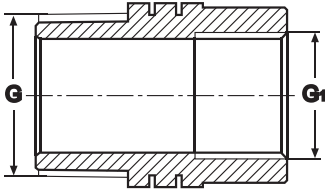

**DIŞLİ REDÜKSİYON ERKEK - DIŞİ**  
THREADED REDUCING MALE - FEMALE  
BUSHING

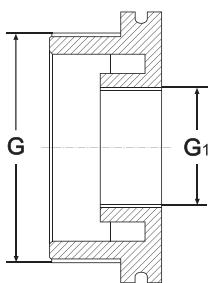

KOD CODE	EBAT / SIZE G x G <sub>1</sub>	BASINÇ DEĞERİ PRESSURE VALUE PN	AMBALAJ ADEDİ PACKING QUANTITY	KOLİ ADEDİ BOX QUANTITY
13911	1/2" x 1/2"	10	50	1600
13912	1/2" x 3/4"	10	50	1150
13913	1/2" x 1"	10	50	600
13922	3/4" x 3/4"	10	50	1100
13923	3/4" x 1"	10	50	600
13933	1" x 1"	10	50	550
13944	1 1/4" x 1 1/4"	10	15	240
13945	1 1/4" x 1 1/2"	10	15	270
13954	1 1/2" x 1 1/4"	10	15	300
13955	1 1/2" x 1 1/2"	10	15	210
13956	1 1/2" x 2"	10	15	180
13957	1 1/2" x 2 1/2"	10	15	120
13966	2" x 2"	10	15	150
13967	2" x 2 1/2"	10	12	108
13968	2" x 3"	10	6	84
13969	2" x 4"	10	4	56
13977	2 1/2" x 2 1/2"	10	12	84
13978	2 1/2" x 3"	10	6	72
13979	2 1/2" x 4"	10	4	48
13988	3" x 3"	10	6	66
13989	3" x 4"	10	4	48
13999	4" x 4"	10	4	40

KOD CODE	EBAT / SIZE G x G <sub>1</sub>	BASINÇ DEĞERİ PRESSURE VALUE PN	AMBALAJ ADEDİ PACKING QUANTITY	KOLİ ADEDİ BOX QUANTITY
13910	1/2" x 1/4"	10	50	2200
13921	3/4" x 1/2"	10	50	1900
13930	1" x 1/4"	10	50	1300
13931	1" x 1/2"	10	50	1300
13932	1" x 3/4"	10	50	1300
13941	1 1/4" x 1/2"	10	25	700
13942	1 1/4" x 3/4"	10	25	675
13943	1 1/4" x 1"	10	25	600
13951	1 1/2" x 1/2"	10	15	390
13952	1 1/2" x 3/4"	10	15	360
13953	1 1/2" x 1"	10	15	360
13961	2" x 1/2"	10	15	270
13962	2" x 3/4"	10	15	255
13963	2" x 1"	10	15	240
13964	2" x 1 1/4"	10	15	255
13965	2" x 1 1/2"	10	15	255
13973	2 1/2" x 1"	10	12	144
13974	2 1/2" x 1 1/4"	10	12	144
13975	2 1/2" x 1 1/2"	10	12	144
13976	2 1/2" x 2"	10	12	144
13984	3" x 1 1/4"	10	12	96
13985	3" x 1 1/2"	10	12	96
13986	3" x 2"	10	12	96
13987	3" x 2 1/2"	10	12	96
13996	4" x 2"	10	6	60
13997	4" x 2 1/2"	10	6	60
13998	4" x 3"	10	6	60

KOD CODE	EBAT / SIZE G, x G, x G	BASINÇ DEĞERİ PRESSURE VALUE PN	AMBALAJ ADEDİ PACKING QUANTITY	KOLİ ADEDİ BOX QUANTITY
14333	1" x 1" x 1"	10	6	270



**MTT-100 KOLLEKTÖR TE**  
MTT-100 MANIFOLD TEE

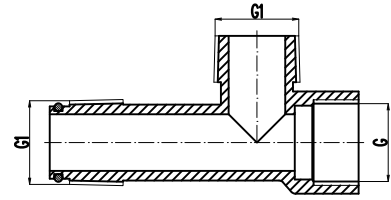

## DİŞLİ BAĞLANTI ELEMANLARI THREADED FITTINGS

### DİKKAT EDİLMESİ GEREKEN HUSUSLAR

- + Ürünlerde diş kısımlarına sızdırmazlık için teflon vb. sızdırmazlık elemanı kullanılmalıdır.
- + Ürünler diş bitiminden sonra aşırı zorlanmamalıdır.

### POINTS TO TAKE INTO CONSIDERATION

- + Sealing elements such as Teflon should be used to seal the threads of the products.
- + Products should not be forced after thread end.

## MAVİ SERİ KÜRESEL VANA

### BLUE SERIES BALL VALVES

## Özellikler

- + Darbelere karşı dayanıklı, yüksek kaliteli polipropilen hammaddeden üretilmiştir
- + Vananın her iki yönünden de akış sağlamak mümkündür.
- + Akışkan geçişinde **basınç ve debi** kaybına sebep olmaz.
- + Sisteminizde **kolay montaj** imkânı sağlar.
- + Oring kauçuktan üretilmekte olup **yüksek basınç altında sızdırmazlık sağlar.**
- + Suyun kokusunu ve tadını değiştirebilecek **zararlı bileşimler içermez.**

## Specifications

- + It has been produced from high quality polypropylene raw material and **it has resistance to impact.**
- + **It is possible to provide bidirectional flow in the valve.**
- + They do not cause any **pressure or flow** loss during fluid transition.
- + They supply **simple installation** in your system.
- + O-rings are made of rubber and **provide leakproofness under high pressure.**
- + It does not contain any **harmful compounds** which can change the taste or the smell of the water.

### GARANTİ VERİLEN BASINÇ DEĞERLERİ

½" - ¾" - 1" - 1 ¼" - 1 ½" - 2" Küresel Vanalar : PN 10

2 ½" - 3" - 4" Küresel Vanalar : PN 6

### GUARANTEED PRESSURE VALUES

½" - ¾" - 1" - 1 ¼" - 1 ½" - 2" Ball Valves : PN 10

2 ½" - 3" - 4" Ball Valves : PN 6



### KULLANIM ALANLARI

- + Peyzaj Sektörü
- + Tarımsal Sulama

### INSTALLATION AREAS

- + Landscaping Systems
- + Agricultural Irrigation



# MAVİ SERİ KÜRESEL VANA / BLUE SERIES BALL VALVES

KOD CODE	EBAT / SIZE D x D	BASINÇ DEĞERİ PRESSURE VALUE PN	AMBALAJ ADEDİ PACKING QUANTITY	KOLİ ADEDİ BOX QUANTITY
993711	1/2" x 1/2"	10	10	200
993722	3/4" x 3/4"	10	6	132
993733	1" x 1"	10	5	100
993744	1 1/4" x 1 1/4"	10	4	72
993755	1 1/2" x 1 1/2"	10	4	56
993766	2" x 2"	10	2	28
993777	2 1/2" x 2 1/2"	6	2	16
993788	3" x 3"	6	1	8
993799	4" x 4"	6	1	8

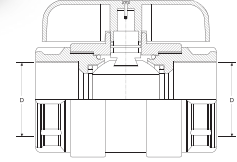

**KÜRESEL VANA DIŞI - DIŞI**  
BALL VALVE FEMALE - FEMALE

KOD CODE	EBAT / SIZE d x D	BASINÇ DEĞERİ PRESSURE VALUE PN	AMBALAJ ADEDİ PACKING QUANTITY	KOLİ ADEDİ BOX QUANTITY
994711	20 x 1/2"	10	10	180
994722	25 x 3/4"	10	6	120
994733	32 x 1"	10	5	75
994744	40 x 1 1/4"	10	4	52
994755	50 x 1 1/2"	10	4	40
994766	63 x 2"	10	2	18

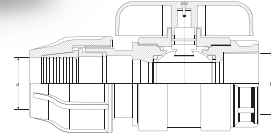

**KÜRESEL VANA KABLİN - DIŞI**  
BALL VALVE COUPLING - FEMALE

KOD CODE	EBAT / SIZE d x d	BASINÇ DEĞERİ PRESSURE VALUE PN	AMBALAJ ADEDİ PACKING QUANTITY	KOLİ ADEDİ BOX QUANTITY
995711	20 x 20	10	10	150
995722	25 x 25	10	6	96
995733	32 x 32	10	5	60
995744	40 x 40	10	4	40
995755	50 x 50	10	4	32
995766	63 x 63	10	2	16

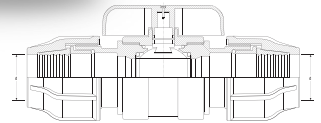

**KÜRESEL VANA KABLİN - KABLİN**  
BALL VALVE COUPLING - COUPLING

**POELSAN®**  
**YEŞİL SERİ KÜRESEL VANA**  
GREEN SERIES BALL VALVES

## Özellikler

- + Darbelere karşı dayanıklı, yüksek kaliteli polipropilen hammaddeden üretilmiştir
- + Vananın her iki yönünden de akış sağlamak mümkündür.
- + Akışkan geçişinde basınç ve debi kaybına sebep olmaz.
- + Sisteminizde kolay montaj imkânı sağlar.
- + Oring kauçuktan üretilmekte olup yüksek basınç altında sızdırmazlık sağlar.
- + Suyun kokusunu ve tadını değiştirebilecek zararlı bileşimler içermez.

## Specifications

- + It has been produced from high quality polypropylene raw material and it has resistance to impact.
- + It is possible to provide bidirectional flow in the valve.
- + They do not cause any pressure or flow loss during fluid pass.
- + They supply simple installation in your system.
- + O-rings are made of rubber and provide leakproofness under high pressure.
- + It does not contain any harmful compounds which can change the taste or the smell of the water.

**GARANTİ VERİLEN BASINÇ DEĞERİ : PN 10**  
**GUARANTEED PRESSURE VALUE : PN 10**

**TSE**  
**ISO 24649**



### KULLANIM ALANLARI

- + Peyzaj Sektörü
- + Tarımsal Sulama

### INSTALLATION AREAS

- + Landscaping Systems
- + Agricultural Irrigation



# YEŞİL SERİ KÜRESEL VANA / GREEN SERIES BALL VALVES

KOD CODE	EBAT / SIZE G x D	BASINÇ DEĞERİ PRESSURE VALUE PN	AMBALAJ ADEDİ PACKING QUANTITY	KOLİ ADEDİ BOX QUANTITY
99122	¾" x ¾"	10	4	140
99123	¾" x 1"	10	4	128
99132	1" x ¾"	10	4	140
99133	1" x 1"	10	4	140
99134	1" x 1 ¼"	10	4	64
99143	1 ¼" x 1"	10	4	64
99144	1 ¼" x 1 ¼"	10	4	64
99145	1 ¼" x 1 ½"	10	2	40
99154	1 ½" x 1 ¼"	10	2	40
99155	1 ½" x 1 ½"	10	2	40
99156	1 ½" x 2"	10	2	32
99165	2" x 1 ½"	10	2	30
99166	2" x 2"	10	2	30

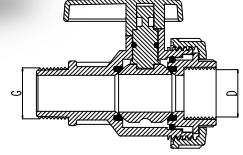

**KÜRESEL VANA ERKEK - DIŞI**  
BALL VALVE MALE - FEMALE

KOD CODE	EBAT / SIZE G x d	BASINÇ DEĞERİ PRESSURE VALUE PN	AMBALAJ ADEDİ PACKING QUANTITY	KOLİ ADEDİ BOX QUANTITY
99222	¾" x 25	10	4	50
99233	1" x 32	10	4	50
99234	1" x 40	10	4	48
99244	1 ¼" x 40	10	4	44
99245	1 ¼" x 50	10	2	30
99255	1 ½" x 50	10	2	28
99256	1 ½" x 63	10	2	18
99266	2" x 63	10	2	18

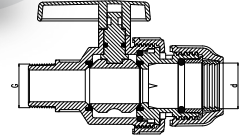

**KÜRESEL VANA ERKEK - KABLİN**  
BALL VALVE MALE - COUPLING

KOD CODE	EBAT / SIZE G x D	BASINÇ DEĞERİ PRESSURE VALUE PN	AMBALAJ ADEDİ PACKING QUANTITY	KOLİ ADEDİ BOX QUANTITY
99322	¾" x ¾"	10	4	140
99332	1" x ¾"	10	4	140
99333	1" x 1"	10	4	140
99343	1 ¼" x 1"	10	4	60
99344	1 ¼" x 1 ¼"	10	4	64
99354	1 ½" x 1 ¼"	10	2	48
99355	1 ½" x 1 ½"	10	2	48
99365	2" x 1 ½"	10	2	30
99366	2" x 2"	10	2	30

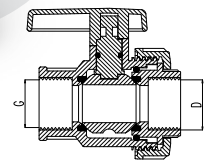

**KÜRESEL VANA DIŞI - DIŞI**  
BALL VALVE FEMALE - FEMALE

# YEŞİL SERİ KÜRESEL VANA / GREEN SERIES BALL VALVES

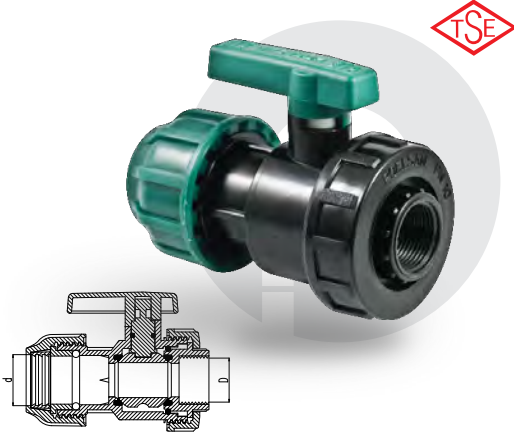

**KÜRESEL VANA KABLİN - DIŞI**  
BALL VALVE COUPLING - FEMALE

KOD CODE	EBAT / SIZE d x D	BASINÇ DEĞERİ PRESSURE VALUE PN	AMBALAJ ADEDİ PACKING QUANTITY	KOLİ ADEDİ BOX QUANTITY
99432	32 x ¾"	10	4	100
99433	32 x 1"	10	4	100
99443	40 x 1"	10	4	48
99444	40 x 1 ¼"	10	4	48
99454	50 x 1 ¼"	10	2	36
99455	50 x 1 ½"	10	2	36
99465	63 x 1 ½"	10	2	20
99466	63 x 2"	10	2	20

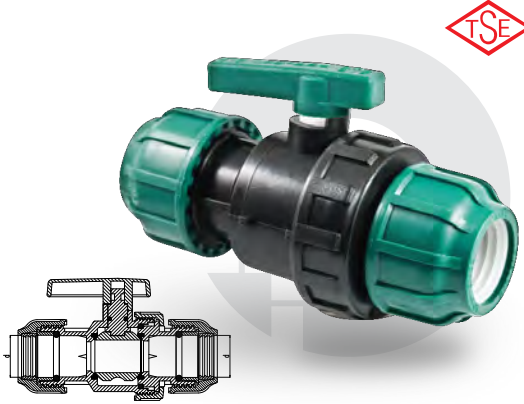

**KÜRESEL VANA KABLİN - KABLİN**  
BALL VALVE COUPLING - COUPLING

KOD CODE	EBAT / SIZE d x d	BASINÇ DEĞERİ PRESSURE VALUE PN	AMBALAJ ADEDİ PACKING QUANTITY	KOLİ ADEDİ BOX QUANTITY
99544	40 x 40	10	4	36
99555	50 x 50	10	2	24
99566	63 x 63	10	2	16

## YEŞİL/MAVİ SERİ KÜRESEL VANA GREEN / BLUE SERIES BALL VALVES

### DIKKAT EDİLMESİ GEREKEN HUSUSLAR

- + Kullanılacak sistemde Filtre kullanılmalıdır.
- + Filtre kullanılmayan durumlarda vana içerisindeki parçalar zarar görebilir, çalışma ömrü kısalmır.
- + Vanalar sökülüp takılabilen parçalardan meydana gelmektedir. Sökülen parçaların tekrar yerine doğru montajı yapılmalıdır.
- + Dişli kısımların montajında teflon vb. sızdırmazlık elemanı kullanılmalıdır.
- + Küresel vanalar su dışındaki akışkanlar için kullanıma uygun değildir.

### POINTS TO TAKE INTO CONSIDERATION

- + The filter should be used in the system.
- + When the filter is not used, the parts inside the valve may be damaged, and the working life will be shortened.
- + Valves consist of parts that can be disassembled, and assembled. The dismantled parts must be assembled correctly.
- + Sealing elements such as Teflon etc. should be used in the assembly of the threaded parts.
- + Ball valves are not suitable for fluids other than water.

## CAN SUYU VANA

### QUICK COUPLING VALVE

## Özellikler

- + Çeyrek tur kolay açma ve kapama kolaylığı,
- + Vana içerisine pislik girmesini önleyen kilitli kapak,
- + UV Dirençli, darbelere karşı dayanıklı hammadde,
- + Diş ölçüleri ISO 7-1 standardına uygundur,
- + ASETAL Yay İç Kovan,
- + Paslanmaz Çelik yay,

## Specifications

- + Easy open and close operation thanks to quarter turn,
- + Locking cover designed to prevent dirt from entering quick coupling valve,
- + UV Resistant, impact resistant raw material
- + Thread size compatible with ISO 7-1 standarts
- + Acetal bushing inner spring
- + Stainless steel spring

**GARANTİ VERİLEN BASINÇ DEĞERİ : PN 6**  
**GUARANTEED PRESSURE VALUE : PN 6**

### KULLANIM ALANLARI

- + Peyzaj Sektörü
- + Bahçe Sulama
- + Spor Tesisleri

### INSTALLATION AREAS

- + Landscaping Systems
- + Agricultural Irrigation
- + Sport Facilities



## CAN SUYU VANA / QUICK COUPLING VALVE

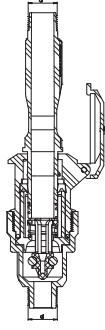

**CAN SUYU VANA - ANAHTAR**  
QUICK COUPLING VALVE - KEY

KOD CODE	EBAT / SIZE d x d	BASINÇ DEĞERİ PRESSURE VALUE PN	AMBALAJ ADEDİ PACKING QUANTITY	KOLİ ADEDİ BOX QUANTITY
CS122	3/4"	6	1	70

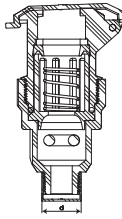

**CAN SUYU VANA**  
QUICK COUPLING VALVE

KOD CODE	EBAT / SIZE d	BASINÇ DEĞERİ PRESSURE VALUE PN	AMBALAJ ADEDİ PACKING QUANTITY	KOLİ ADEDİ BOX QUANTITY
CS322	3/4"	6	5	300

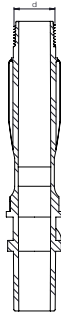

**CAN SUYU ANAHTAR**  
QUICK COUPLING KEY

KOD CODE	EBAT / SIZE d	BASINÇ DEĞERİ PRESSURE VALUE PN	AMBALAJ ADEDİ PACKING QUANTITY	KOLİ ADEDİ BOX QUANTITY
CS222	3/4"	6	5	120

## CAN SUYU VANA QUICK COUPLING VALVE

### DİKKAT EDİLMESİ GEREKEN HUSUSLAR

- + Gövde dişli kısmı gevşetilmemelidir.
- + Anahtarın vanaya montajı öncesinde hortum bağlantısı yapılmalıdır.
- + 3/4" Dişli kısımlar için Sızdırmazlık elemanı (Teflon vb.) kullanılmalıdır.

### POINTS TO TAKE INTO CONSIDERATION

- + Body part of the product should not be loosened.
- + Hose pipe assembly should be completed before the assembly of quick coupling valve with the key.
- + It is recommended for waterproofness of threaded parts to use teflon band and so on.

## VANA KUTULARI

### VALVE BOXES

### Özellikler

- + **Yüksek kaliteli** polipropilen hammaddeden üretilmiştir.
- + Toprak altına döşenmiş sistem ekipmanlarına **kolay ulaşım** sağlar.
- + Kapak içerisinde **özel tasarım plastik kilit sistemi** mevcuttur.
- + Boru geçişleri için boru çaplarına göre **özel kesimli** delikler bulunmaktadır.

### Vanalı Vana Kutusu Özellikleri

- + Hortum çıkış yeri özel sürgülü kapak ile tam kapama sağlar.
- + Kutunun içerisinde su birikmesini önleyecek su tahliye delikleri bulunmaktadır.
- + **3/4" BSP/Erkek Bağlantı** çıkış mevcuttur.
- + Max. Çalışma **basıncı 16 Bar**'dir.
- + Paslanmaya dayanıklı metal vana bulunmaktadır.

### KULLANIM ALANLARI

- + Peyzaj Sektörü
- + Tarımsal Sulama
- + İnşaat Sektörü

### INSTALLATION AREAS

- + Landscaping Systems
- + Agricultural Irrigation
- + Construction

### Specifications

- + It has been produced from **high quality** polypropylene raw material.
- + It enables **easy access** to the system equipment which is laid underground.
- + **Specially designed plastic lock system** is available in the lid.
- + There are **specially cut** holes according to pipe diameters for the passages of pipe.

### Specifications

- + The hose outlet provides full closure with a special sliding cover.
- + There are water drainage holes in the box to prevent water from accumulating.
- + **3/4" BSP/Male Connection** output is available.
- + Max. Working pressure is **16 Bar**.
- + There is a rust-proof metal valve.





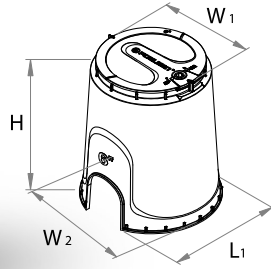

## YENİ NESİL VANA KUTUSU NEW GENERATION VALVE BOXES

KOD CODE	EBAT SIZE	AMBALAJ ADEDİ PACKING QUANTITY	PALET ADEDİ PALLET QUANTITY	
74006	6"	1	648	
YÜKSEKLİK / HEIGHT		UZUNLUK / LENGTH		GENİŞLİK / WIDTH
H (mm)	L <sub>1</sub> (mm)	W <sub>1</sub> (mm)	W <sub>2</sub> (mm)	
230	190	170	205	

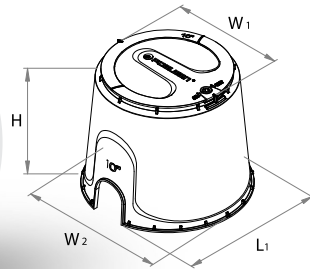

## YENİ NESİL VANA KUTUSU NEW GENERATION VALVE BOXES

KOD CODE	EBAT SIZE	AMBALAJ ADEDİ PACKING QUANTITY	PALET ADEDİ PALLET QUANTITY	
74010	10"	1	240	
YÜKSEKLİK / HEIGHT		UZUNLUK / LENGTH		GENİŞLİK / WIDTH
H (mm)	L <sub>1</sub> (mm)	W <sub>1</sub> (mm)	W <sub>2</sub> (mm)	
250	305	310	305	

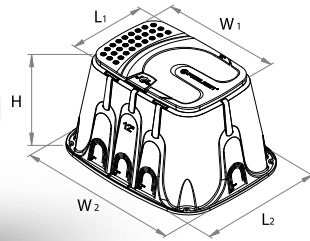

## YENİ NESİL VANA KUTUSU NEW GENERATION VALVE BOXES

KOD CODE	EBAT SIZE	AMBALAJ ADEDİ PACKING QUANTITY	PALET ADEDİ PALLET QUANTITY		
74012	12"	1	100		
YÜKSEKLİK / HEIGHT		UZUNLUK / LENGTH		GENİŞLİK / WIDTH	
H (mm)	L <sub>1</sub> (mm)	L <sub>2</sub> (mm)	W <sub>1</sub> (mm)	W <sub>2</sub> (mm)	
295	265	420	390	525	

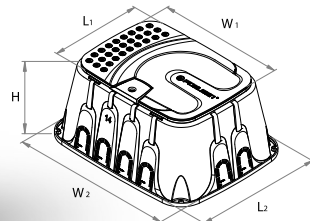

## YENİ NESİL VANA KUTUSU NEW GENERATION VALVE BOXES

KOD CODE	EBAT SIZE	AMBALAJ ADEDİ PACKING QUANTITY	PALET ADEDİ PALLET QUANTITY		
74014	14" (jumbo)	1	50		
YÜKSEKLİK / HEIGHT		UZUNLUK / LENGTH		GENİŞLİK / WIDTH	
H (mm)	L <sub>1</sub> (mm)	L <sub>2</sub> (mm)	W <sub>1</sub> (mm)	W <sub>2</sub> (mm)	
295	380	525	525	670	

## PROFESYONEL VANA KUTUSU PROFESSIONAL VALVE BOXES

KOD CODE	EBAT SIZE	AMBALAJ ADEDİ PACKING QUANTITY	PALET ADEDİ PALLET QUANTITY	
73006	6"	1	360	
YÜKSEKLİK / HEIGHT	UZUNLUK / LENGTH		GENİŞLİK / WIDTH	
H (mm)	L <sub>1</sub> (mm)	L <sub>2</sub> (mm)	W <sub>1</sub> (mm)	W <sub>2</sub> (mm)
235	163	260	163	260

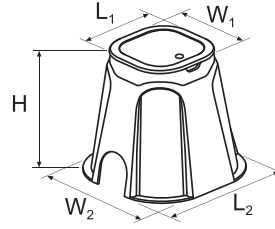

## PROFESYONEL VANA KUTUSU PROFESSIONAL VALVE BOXES

KOD CODE	EBAT SIZE	AMBALAJ ADEDİ PACKING QUANTITY	PALET ADEDİ PALLET QUANTITY	
73010	10"	1	240	
YÜKSEKLİK / HEIGHT	UZUNLUK / LENGTH		GENİŞLİK / WIDTH	
H (mm)	L <sub>1</sub> (mm)	L <sub>2</sub> (mm)	W <sub>1</sub> (mm)	W <sub>2</sub> (mm)
275	240	375	240	375

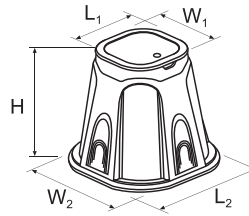

## PROFESYONEL VANA KUTUSU PROFESSIONAL VALVE BOXES

KOD CODE	EBAT SIZE	AMBALAJ ADEDİ PACKING QUANTITY	PALET ADEDİ PALLET QUANTITY	
73012	12"	1	120	
YÜKSEKLİK / HEIGHT	UZUNLUK / LENGTH		GENİŞLİK / WIDTH	
H (mm)	L <sub>1</sub> (mm)	L <sub>2</sub> (mm)	W <sub>1</sub> (mm)	W <sub>2</sub> (mm)
310	385	553	255	420

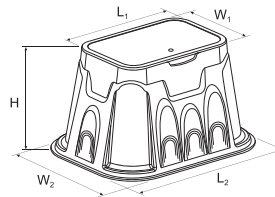

## PROFESYONEL VANA KUTUSU PROFESSIONAL VALVE BOXES

KOD CODE	EBAT SIZE	AMBALAJ ADEDİ PACKING QUANTITY	PALET ADEDİ PALLET QUANTITY	
73014	14" (jumbo)	1	50	
YÜKSEKLİK / HEIGHT	UZUNLUK / LENGTH		GENİŞLİK / WIDTH	
H (mm)	L <sub>1</sub> (mm)	L <sub>2</sub> (mm)	W <sub>1</sub> (mm)	W <sub>2</sub> (mm)
310	505	673	355	520

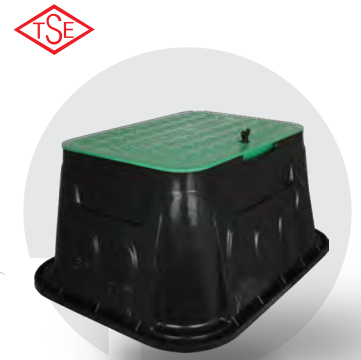
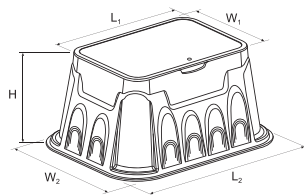

# VANALI VANA KUTUSU / VALVE BOX WITH VALVE

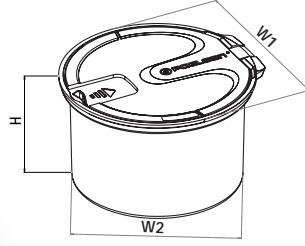

## VANALI VANA KUTUSU VALVE BOX WITH VALVE

KOD CODE	EBAT SIZE	VANA MODEL VALVE MODEL	KOLİ ADEDİ PACKING QUANTITY	PALET ADEDİ PALLET QUANTITY
73122	3/4"	Erkek / Male	15	270
73222	3/4"	Dişi / Female	15	270

YÜKSEKLİK / HEIGHT	GENİŞLİK / WIDTH	
H (mm)	W <sub>1</sub> (mm)	W <sub>2</sub> (mm)
127	212	183

## VANA KUTULARI VALVE BOXES

### DİKKAT EDİLMESİ GEREKEN HUSUSLAR

- + Keskin köşeli darbelere karşı koruyunuz.
- + Boru çaplarına göre özel kesimli delikler testere yardımı ile ihtiyaca göre kesilmelidir.
- + Kilit sistemini açmak için 8 mm alyan anahtar kullanılmalıdır.

### POINTS TO TAKE INTO CONSIDERATION

- + Protect against sharp-edged impacts.
- + Special cut holes according to pipe diameters should be cut by means of a saw according to need.
- + 8 mm allen key must be used to unlock the locking system.

## PLASTİK FİLTRELER

### PLASTIC FILTERS

## Özellikler

- + Yüksek kaliteli polipropilen malzemeden üretilmiştir.
- + Minimum basınç kaybına sahiptir.
- + Geniş debi aralığında çalışma kabiliyetine sahiptir.
- + Kolay temizlenebilirlik ve esnek bakım odaklı ürün tasarımına sahiptir.
- + Hassas partikül tutma özelliğine sahiptir.
- + 120 Mesh Elek ve Disk Kartuş Seçeneğine sahiptir.
- + Elek: Paslanmaz Çelik, Disk: Polipropilen (PP) hammadde' den oluşmaktadır.
- + Korozyon ve kimyasallara karşı yüksek hassasiyet sağlar.
- + 1/4" : Filtre Manometre Çıkış,  
3/4" : Filtre Tahliye Vana Çıkış

## Specifications

- + Made of high quality polypropylene material.
- + It has minimal pressure loss.
- + It has the ability to work in a wide flow range.
- + It has a product design focused on easy cleaning and flexible maintenance.
- + It has sensitive particle retention.
- + It has 120 Mesh Screen and Disc Cartridge Options.
- + It consists of sieve: Stainless Steel, Disc: Polypropylene (PP) raw material.
- + It provides high sensitivity against corrosion and chemicals.
- + 1/4" : Filter Manometer Output,  
3/4" : Filter Relief Valve Outlet

**GARANTİ VERİLEN BASINÇ DEĞERİ** : PN 10  
**GUARANTEED PRESSURE VALUE** : PN 10

### KULLANIM ALANLARI

- + Peyzaj Sektörü
- + Tarımsal Sulama

### INSTALLATION AREAS

- + Landscaping Systems
- + Agricultural Irrigation

 **130 Micron  
(120 Mesh)**



# PLASTİK FİLTRELER / PLASTIC FILTERS



KOD CODE	EBAT / SIZE D	BASINÇ DEĞERİ PRESSURE VALUE PN	AMBALAJ ADEDİ PACKING QUANTITY	KOLİ ADEDİ BOX QUANTITY	K	H	D1	M
291112022	¾"	10	1	50	154	183	67	1/4"
291112033	1"	10	1	50	166	183	67	1/4"
291212044	1 ¼"	10	1	21	231	209	96	1/4"
291212055	1 ½"	10	1	20	231	209	96	1/4"
291312066	2"	10	1	10	264	260	122	1/4"

## PLASTİK FİLTRE ELEK PLASTIC FILTER – SIEVE

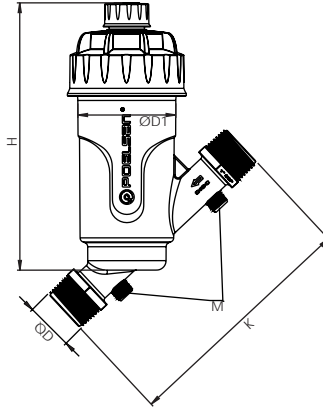

KOD CODE	EBAT / SIZE D	BASINÇ DEĞERİ PRESSURE VALUE PN	AMBALAJ ADEDİ PACKING QUANTITY	KOLİ ADEDİ BOX QUANTITY	K	H	D1	M
292112022	¾"	10	1	50	154	183	67	1/4"
292112033	1"	10	1	50	166	183	67	1/4"
292212044	1 ¼"	10	1	21	231	209	96	1/4"
292212055	1 ½"	10	1	20	231	209	96	1/4"
292312066	2"	10	1	10	264	260	122	1/4"

## PLASTİK FİLTRE DİSK PLASTIC FILTER – DISC

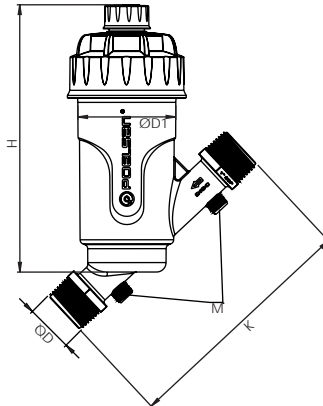



# PLASTİK FİLTRELER

## PLASTIC FILTERS

EBAT SIZE	MAX. DEBİ MAXIMUM FLOW	FİLTRE YÜZEYİ (DİSK) FILTERING SURFACE (DISC)	FİLTRE YÜZEYİ (ELEK) FILTERING SURFACE (SCREEN)
3/4"	5 m <sup>3</sup> /h	165 cm <sup>2</sup>	180 cm <sup>2</sup>
1"	6 m <sup>3</sup> /h	165 cm <sup>2</sup>	180 cm <sup>2</sup>
1 1/4"	10 m <sup>3</sup> /h	265 cm <sup>2</sup>	280 cm <sup>2</sup>
1 1/2"	14 m <sup>3</sup> /h	265 cm <sup>2</sup>	280 cm <sup>2</sup>
2"	25 m <sup>3</sup> /h	485 cm <sup>2</sup>	500 cm <sup>2</sup>

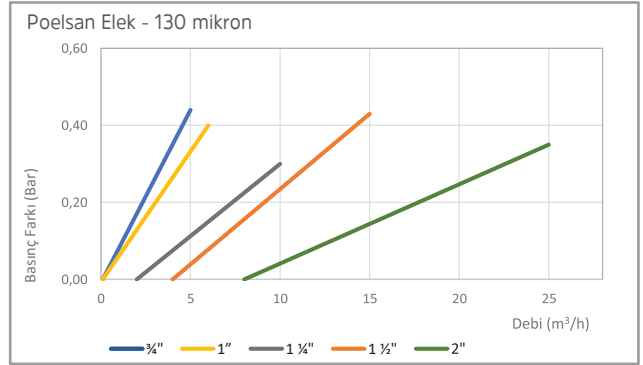
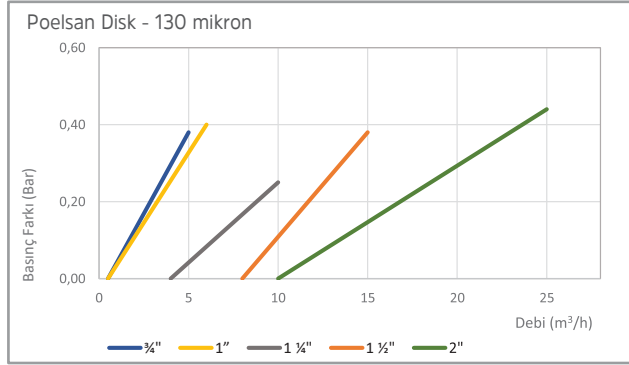

## DİKKAT EDİLMESİ GEREKEN HUSUSLAR

- + Elek ve disk Filtrede bağlantı yönüne dikkat edilmelidir.
- + Sistem çalıştırılmadan önce filtrenin temiz olup olmadığı kontrol edilmelidir.
- + Filtre giriş ile çıkış basınçları arasında fark 1 bar dan fazla görüldüğünde Filtre temizlenmelidir.
- + Sistemin sağlıklı çalışması için filtreler düzenli temizlenmelidir.
- + Tahliye vana montajı için filtre kapak üzerinde bulunan kör tapa çıkartılır ve bir matkap yardımı ile delinerek 3/4\" dişi vana montajı yapılır.

## POINTS TO TAKE INTO CONSIDERATION

- + In the sieve and disc filter, attention should be paid to the connection direction.
- + Before the system is started, it should be checked whether the filter is clean.
- + When the difference between the filter inlet and outlet pressures is more than 1 bar, the filter should be cleaned.
- + In order for the system to work properly, the filters must be cleaned regularly.
- + For the installation of the discharge valve, the blind plug on the filter cover is removed and a 3/4\" female valve is mounted by drilling it with the help of a drill.

## MINI VANA (DN 8)

MINI VALVE

### Özellikler

- + Su geçiş çapı 8 mm.
- + Darbelere karşı dayanıklı, yüksek kaliteli polipropilen hammaddeden üretilmiştir.
- + Sulama sisteminizi kolayca açıp kapayarak kontrol etmenizi sağlar.
- + UV ışınlarını geçirmediği için yosunlanmaya ve bakteri üremesine izin vermez.
- + Oringi kauçuktan üretilmekte olup yüksek basınç altında sızdırmazlık sağlar.
- + İç yüzeyleri homojen ve gözeneksizdir.
- + Suyun kokusunu ve tadını değiştirebilecek zararlı bileşikler içermez.

### Specifications

- + Water pass diameter 8 mm.
- + It has been produced from high quality polypropylene raw material and it has resistance to impact.
- + It supplies an easy on-off control on the irrigation system.
- + They prevent alga and bacteria forming due to UV proof (ultraviolet beam) structure.
- + O-rings are made of rubber and provide leakproofness under high pressure.
- + It has a homogeneous and non-porous inner surface.
- + It does not contain any harmful compounds which can change the taste or the smell of the water.



TS EN ISO 9261

GARANTİ VERİLEN BASINÇ DEĞERİ : PN 4  
GUARANTEED PRESSURE VALUE : PN 4



### KULLANIM ALANLARI

- + Tarımsal Sulama
- + Peyzaj Sektörü
- + Seralar

### INSTALLATION AREAS

- + Agricultural Irrigation
- + Landscaping Systems
- + Greenhouses

# DAMLA SULAMA MİNİ VANALAR (DN 8) / DRIPLINE MINI VALVES (DN 8)

KOD CODE	EBAT / SIZE d x d	BASINÇ DEĞERİ PRESSURE VALUE PN	AMBALAJ ADEDİ PACKING QUANTITY	KOLİ ADEDİ BOX QUANTITY
11122	16 x 16	4	50	350
11142	20 x 16	4	50	300
11144	20 x 20	4	50	300



**MİNİ VANA KİLİTLİ BAĞLANTI**  
MINI VALVE LOCK TYPE

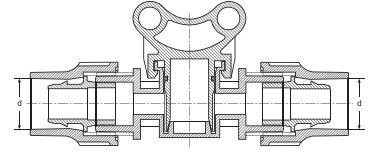

KOD CODE	EBAT / SIZE d x G	BASINÇ DEĞERİ PRESSURE VALUE PN	AMBALAJ ADEDİ PACKING QUANTITY	KOLİ ADEDİ BOX QUANTITY
11221	16 x 1/2"	4	50	500
11222	16 x 3/4"	4	50	450
11241	20 x 1/2"	4	50	450
11242	20 x 3/4"	4	50	400



**MİNİ VANA KİLİTLİ BAĞLANTI - ERKEK**  
MINI VALVE LOCK TYPE - MALE

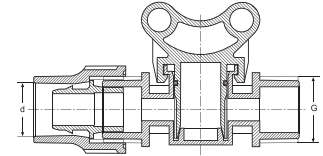

KOD CODE	EBAT / SIZE G x G	BASINÇ DEĞERİ PRESSURE VALUE PN	AMBALAJ ADEDİ PACKING QUANTITY	KOLİ ADEDİ BOX QUANTITY
11311	1/2" x 1/2"	4	50	700
11321	3/4" x 1/2"	4	50	650
11322	3/4" x 3/4"	4	50	600

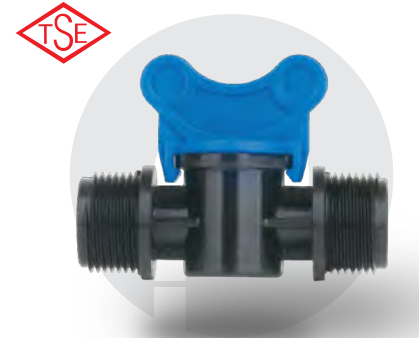

**MİNİ VANA ERKEK**  
MINI VALVE MALE

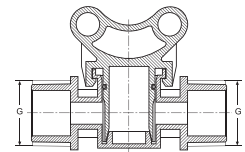

## DAMLA SULAMA MİNİ VANALAR (DN 8) / DRIPLINE MINI VALVES (DN 8)

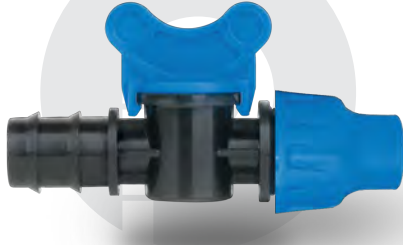

**MİNİ VANA KURTAĞZI - KİLİTLİ BAĞLANTI**  
MINI VALVE BARBED - LOCK TYPE

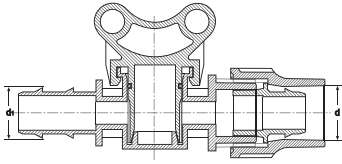

KOD CODE	EBAT / SIZE d, x d	BASINÇ DEĞERİ PRESSURE VALUE PN	AMBALAJ ADEDİ PACKING QUANTITY	KOLİ ADEDİ BOX QUANTITY
11422	16 x 16	4	50	450
11424	16 x 20	4	50	450
11442	20 x 16	4	50	450
11444	20 x 20	4	50	400
11452	25 x 16	4	50	400
11454	25 x 20	4	50	400

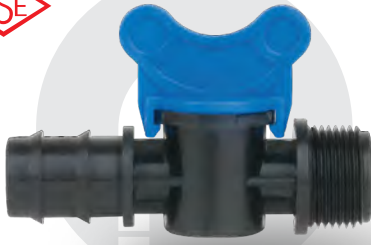

**MİNİ VANA KURTAĞZI - ERKEK**  
MINI VALVE BARBED - MALE

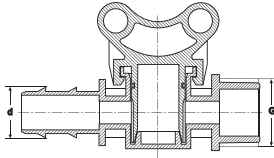

KOD CODE	EBAT / SIZE d x G	BASINÇ DEĞERİ PRESSURE VALUE PN	AMBALAJ ADEDİ PACKING QUANTITY	KOLİ ADEDİ BOX QUANTITY
11521	16 x 1/2"	4	50	700
11522	16 x 3/4"	4	50	600
11541	20 x 1/2"	4	50	700
11542	20 x 3/4"	4	50	600
11551	25 x 1/2"	4	50	600
11552	25 x 3/4"	4	50	600



**MİNİ VANA KURTAĞZI**  
MINI VALVE BARBED

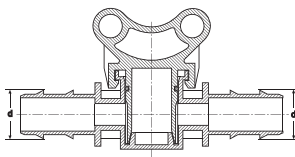

KOD CODE	EBAT / SIZE d x d	BASINÇ DEĞERİ PRESSURE VALUE PN	AMBALAJ ADEDİ PACKING QUANTITY	KOLİ ADEDİ BOX QUANTITY
11622	16 x 16	4	50	650
11624	16 x 20	4	50	600
11625	16 x 25	4	50	600
11644	20 x 20	4	50	600
11645	20 x 25	4	50	550
11655	25 x 25	4	50	500

## DAMLA SULAMA MİNİ VANALAR (DN 8) / DRIPLINE MINI VALVES (DN 8)

KOD CODE	EBAT / SIZE d x c	BASINÇ DEĞERİ PRESSURE VALUE PN	AMBALAJ ADEDİ PACKING QUANTITY	KOLİ ADEDİ BOX QUANTITY
118122	16 x 16	4	50	450
118124	16 x 20	4	50	450
118142	20 x 16	4	50	400
118144	20 x 20	4	50	400

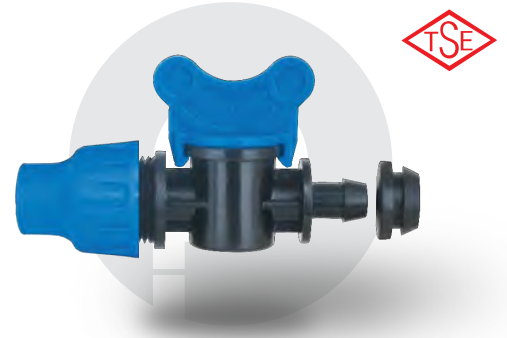

**MİNİ VANA KİLİTLİ BAĞLANTI - GROMMET**  
MINI VALVE LOCK TYPE - GROMMET

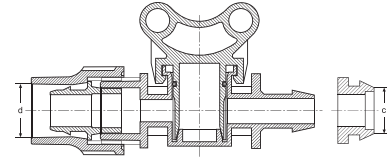

KOD CODE	EBAT / SIZE d	BASINÇ DEĞERİ PRESSURE VALUE PN	AMBALAJ ADEDİ PACKING QUANTITY	KOLİ ADEDİ BOX QUANTITY
118123	16 x 16	4	50	450
118143	20 x 16	4	50	400

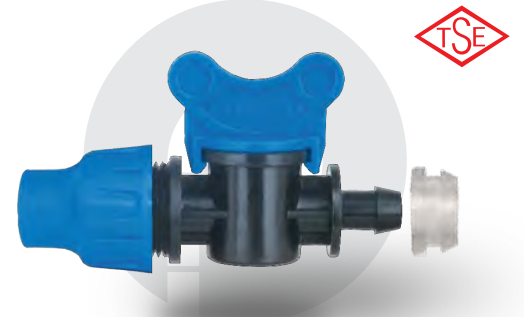

**MİNİ VANA KİLİTLİ BAĞLANTI - GROMMET - D.Ç:18mm**  
MINI VALVE LOCK TYPE - GROMMET - DD:18mm

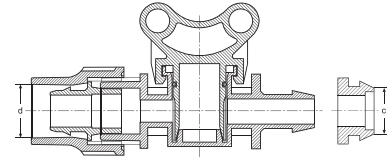

KOD CODE	EBAT / SIZE d	BASINÇ DEĞERİ PRESSURE VALUE PN	AMBALAJ ADEDİ PACKING QUANTITY	KOLİ ADEDİ BOX QUANTITY
118162	16	4	50	400
118182	20	4	50	400

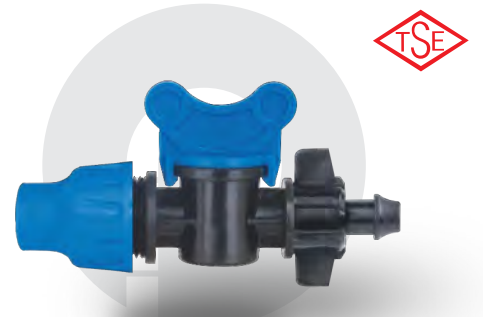

**MİNİ VANA KİLİTLİ BAĞLANTI - CONTASIZ ÇIKIŞ**  
MINI VALVE LOCK TYPE - OFFTAKE WITHOUT GASKET

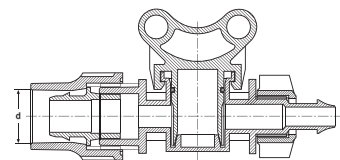

D.Ç:Delme Çapı / DD:Drilling Diameter



## DAMLA SULAMA MİNİ VANALAR (DN 8) / DRILINE MINI VALVES (DN 8)

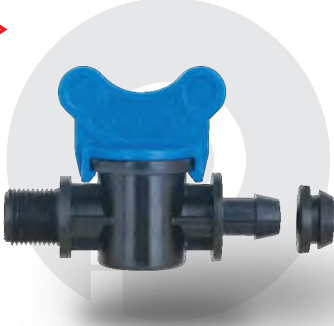

**MİNİ VANA ERKEK - GROMMET**  
MINI VALVE MALE - GROMMET

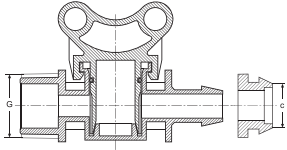

KOD CODE	EBAT / SIZE G x c	BASINÇ DEĞERİ PRESSURE VALUE PN	AMBALAJ ADEDİ PACKING QUANTITY	KOLİ ADEDİ BOX QUANTITY
118212	½" x 16	4	50	700
118214	½" x 20	4	50	600
118222	¾" x 16	4	50	650
118224	¾" x 20	4	50	600

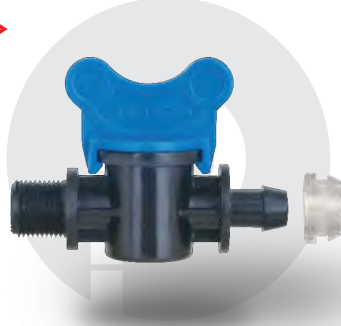

**MİNİ VANA ERKEK - GROMMET - D.Ç:18mm**  
MINI VALVE MALE - GROMMET - DD:18mm

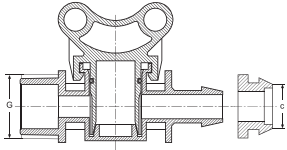

KOD CODE	EBAT / SIZE G x c	BASINÇ DEĞERİ PRESSURE VALUE PN	AMBALAJ ADEDİ PACKING QUANTITY	KOLİ ADEDİ BOX QUANTITY
118213	½" x 16	4	50	700
118223	¾" x 16	4	50	600

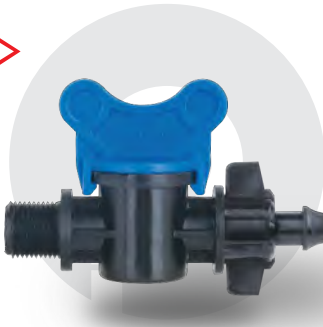

**MİNİ VANA ERKEK - CONTASIZ ÇIKIŞ**  
MINI VALVE MALE - OFFTAKE WITHOUT GASKET

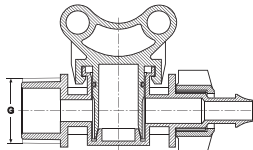

KOD CODE	EBAT / SIZE G	BASINÇ DEĞERİ PRESSURE VALUE PN	AMBALAJ ADEDİ PACKING QUANTITY	KOLİ ADEDİ BOX QUANTITY
118272	½"	4	50	600
118282	¾"	4	50	550

D.Ç:Delme Çapı / DD:Drilling Diameter

## DAMLA SULAMA MİNİ VANALAR (DN 8) / DRIPLINE MINI VALVES (DN 8)

KOD CODE	EBAT / SIZE d x c	BASINÇ DEĞERİ PRESSURE VALUE PN	AMBALAJ ADEDİ PACKING QUANTITY	KOLİ ADEDİ BOX QUANTITY
118322	16 x 16	4	50	650
118324	16 x 20	4	50	600
118342	20 x 16	4	50	600
118344	20 x 20	4	50	600
118352	25 x 16	4	50	550
118354	25 x 20	4	50	500

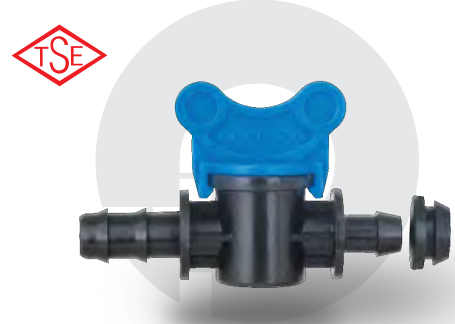

**MİNİ VANA KURTAĞZI - GROMMET**  
MINI VALVE BARBED - GROMMET

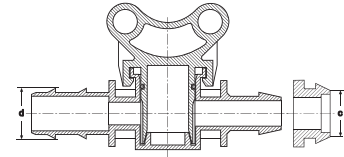

KOD CODE	EBAT / SIZE d x c	BASINÇ DEĞERİ PRESSURE VALUE PN	AMBALAJ ADEDİ PACKING QUANTITY	KOLİ ADEDİ BOX QUANTITY
118323	16 x 16	4	50	600
118343	20 x 16	4	50	600
118353	25 x 16	4	50	600

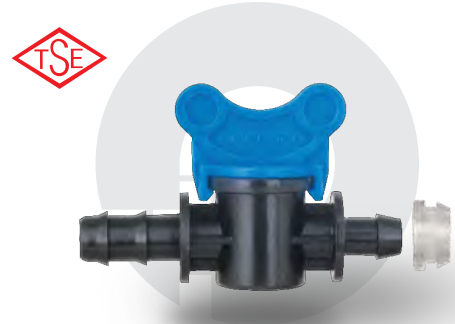

**MİNİ VANA KURTAĞZI - GROMMET - D.Ç:18mm**  
MINI VALVE BARBED - GROMMET - DD:18mm

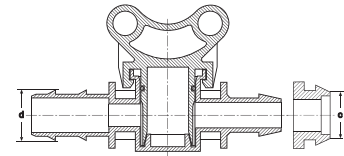

KOD CODE	EBAT / SIZE d	BASINÇ DEĞERİ PRESSURE VALUE PN	AMBALAJ ADEDİ PACKING QUANTITY	KOLİ ADEDİ BOX QUANTITY
118362	16	4	50	600
118382	20	4	50	550
118392	25	4	50	550

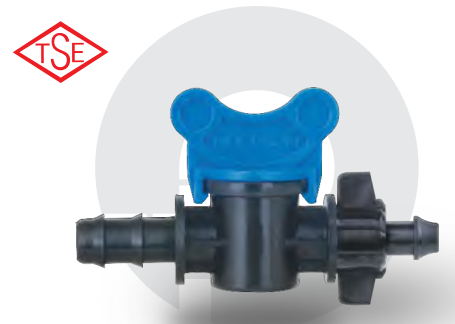

**MİNİ VANA KURTAĞZI - CONTASIZ ÇIKIŞ**  
MINI VALVE BARBED - OFFTAKE WITHOUT GASKET

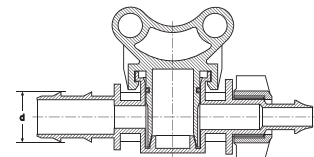

D.Ç:Delme Çapı / DD:Drilling Diameter

## DAMLA SULAMA MİNİ VANALAR (DN 8) / DRIPLINE MINI VALVES (DN 8)

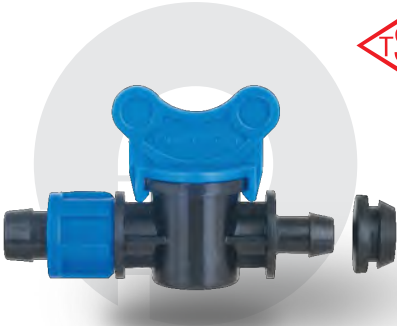

**MİNİ VANA DAMLAMA - GROMMET**  
MINI VALVE DRIPLINE - GROMMET

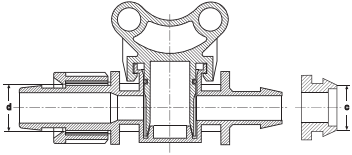

KOD CODE	EBAT / SIZE d x c	BASINÇ DEĞERİ PRESSURE VALUE PN	AMBALAJ ADEDİ PACKING QUANTITY	KOLİ ADEDİ BOX QUANTITY
118422	16 x 16	4	50	600
118442	20 x 16	4	50	550
118444	20 x 20	4	50	500

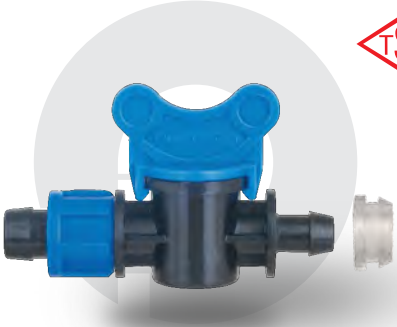

**MİNİ VANA DAMLAMA - GROMMET - D.Ç:18mm**  
MINI VALVE DRIPLINE - GROMMET - DD:18mm

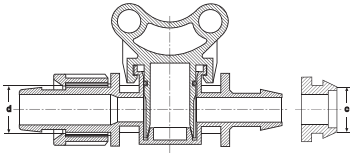

KOD CODE	EBAT / SIZE d x c	BASINÇ DEĞERİ PRESSURE VALUE PN	AMBALAJ ADEDİ PACKING QUANTITY	KOLİ ADEDİ BOX QUANTITY
118423	16 x 16	4	50	600
118443	20 x 16	4	50	550



**MİNİ VANA DAMLAMA - CONTASIZ ÇIKIŞ**  
MINI VALVE DRIPLINE - OFFTAKE WITHOUT GASKET

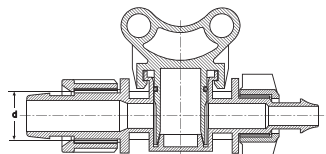

KOD CODE	EBAT / SIZE d	BASINÇ DEĞERİ PRESSURE VALUE PN	AMBALAJ ADEDİ PACKING QUANTITY	KOLİ ADEDİ BOX QUANTITY
118462	16	4	50	550
118482	20	4	50	500

D.Ç:Delme Çapı / DD:Drilling Diameter

## DAMLA SULAMA MİNİ VANALAR (DN 8) / DRIPLINE MINI VALVES (DN 8)

KOD CODE	EBAT SIZE-mm	BASINÇ DEĞERİ PRESSURE VALUE PN	AMBALAJ ADEDİ PACKING QUANTITY	KOLİ ADEDİ BOX QUANTITY
118499	12	4	50	550



**MİNİ VANA CONTASIZ ÇIKIŞ**  
MINI VALVE OFFTAKE WITHOUT GASKET

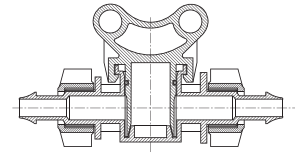

KOD CODE	EBAT / SIZE d x d <sub>1</sub>	BASINÇ DEĞERİ PRESSURE VALUE PN	AMBALAJ ADEDİ PACKING QUANTITY	KOLİ ADEDİ BOX QUANTITY
118622	16 x 16	4	50	450
118642	20 x 16	4	50	400
118644	20 x 20	4	50	400

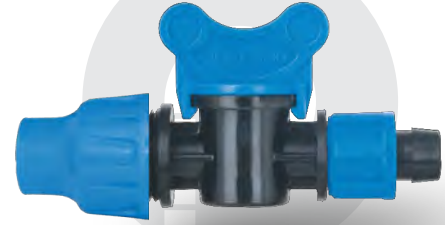

**MİNİ VANA KİLİTLİ BAĞLANTI - DAMLAMA**  
MINI VALVE LOCK TYPE - DRIPLINE

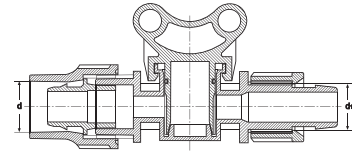

KOD CODE	EBAT / SIZE G x d	BASINÇ DEĞERİ PRESSURE VALUE PN	AMBALAJ ADEDİ PACKING QUANTITY	KOLİ ADEDİ BOX QUANTITY
118712	½" x 16	4	50	650
118714	½" x 20	4	50	600
118722	¾" x 16	4	50	600
118724	¾" x 20	4	50	550



**MİNİ VANA ERKEK - DAMLAMA**  
MINI VALVE MALE - DRIPLINE

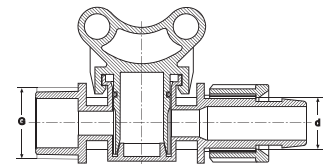

## YASSI DAMLA SULAMA MİNİ VANALAR (DN 8) / TAPE MINI VALVES (DN 8)

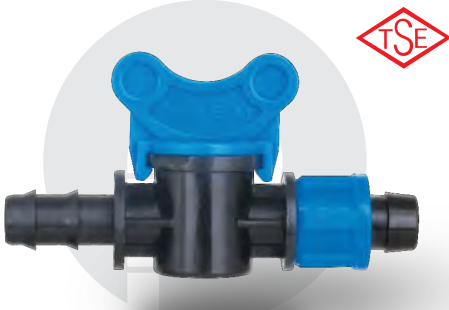

**MİNİ VANA KURTAĞZI - DAMLAMA**  
MINI VALVE BARBED - DRIPLINE

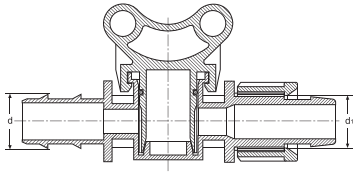

KOD CODE	EBAT / SIZE d x d <sub>1</sub>	BASINÇ DEĞERİ PRESSURE VALUE PN	AMBALAJ ADEDİ PACKING QUANTITY	KOLİ ADEDİ BOX QUANTITY
118822	16 x 16	4	50	600
118824	16 x 20	4	50	550
118842	20 x 16	4	50	550
118844	20 x 20	4	50	500

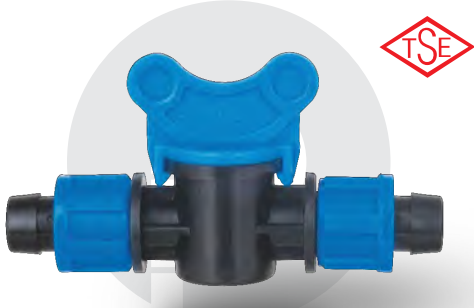

**MİNİ VANA DAMLAMA**  
MINI VALVE DRIPLINE

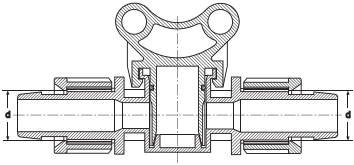

KOD CODE	EBAT / SIZE d x d	BASINÇ DEĞERİ PRESSURE VALUE PN	AMBALAJ ADEDİ PACKING QUANTITY	KOLİ ADEDİ BOX QUANTITY
118922	16 x 16	4	50	550
118924	16 x 20	4	50	500
118944	20 x 20	4	50	450

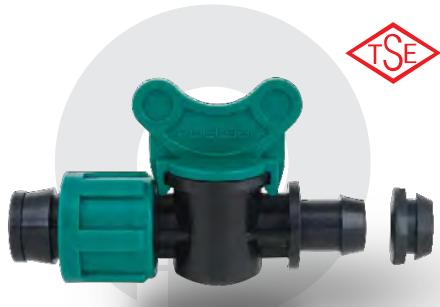

**MİNİ VANA YASSI DAMLAMA - GROMMET**  
MINI VALVE TAPE - GROMMET

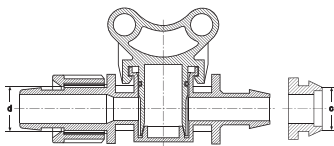

KOD CODE	EBAT / SIZE d x c	BASINÇ DEĞERİ PRESSURE VALUE PN	AMBALAJ ADEDİ PACKING QUANTITY	KOLİ ADEDİ BOX QUANTITY
118522	17 x 16	4	50	650
118524	17 x 20	4	50	600
118542	22 x 16	4	50	500
118544	22 x 20	4	50	450



## YASSI DAMLA SULAMA MİNİ VANALAR (DN 8) / TAPE MINI VALVES (DN 8)

KOD CODE	EBAT / SIZE d x c	BASINÇ DEĞERİ PRESSURE VALUE PN	AMBALAJ ADEDİ PACKING QUANTITY	KOLİ ADEDİ BOX QUANTITY
118523	17 x 16	4	50	600
118543	22 x 16	4	50	500



**MİNİ VANA YASSI DAMLAMA - GROMMET - D.Ç:18mm**  
MINI VALVE TAPE - GROMMET - DD:18mm

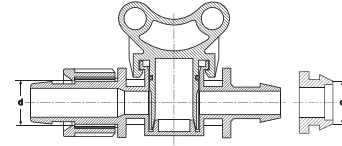

KOD CODE	EBAT / SIZE d	BASINÇ DEĞERİ PRESSURE VALUE PN	AMBALAJ ADEDİ PACKING QUANTITY	KOLİ ADEDİ BOX QUANTITY
118562	17	4	50	550
118582	22	4	50	400



**MİNİ VANA YASSI DAMLAMA - CONTASIZ ÇIKIŞ**  
MINI VALVE TAPE - OFFTAKE WITHOUT GASKET

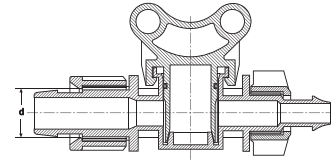

KOD CODE	EBAT / SIZE d x d <sub>1</sub>	BASINÇ DEĞERİ PRESSURE VALUE PN	AMBALAJ ADEDİ PACKING QUANTITY	KOLİ ADEDİ BOX QUANTITY
119022	16 x 17	4	50	450
119024	16 x 22	4	50	350
119042	20 x 17	4	50	400
119044	20 x 22	4	50	350

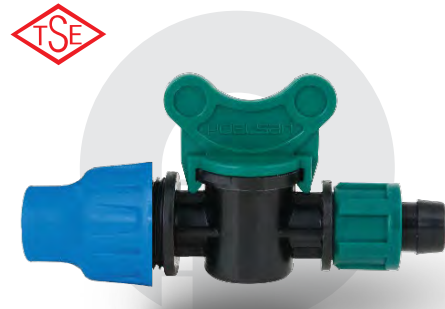

**MİNİ VANA KİLİTLİ BAĞLANTI - YASSI DAMLAMA**  
MINI VALVE LOCK TYPE - TAPE

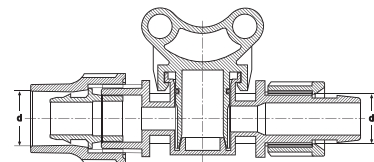

D.Ç:Delme Çapı / DD:Drilling Diameter

## YASSI DAMLA SULAMA MİNİ VANALAR (DN 8) / TAPE MINI VALVES (DN 8)



KOD CODE	EBAT / SIZE G x d	BASINÇ DEĞERİ PRESSURE VALUE PN	AMBALAJ ADEDİ PACKING QUANTITY	KOLİ ADEDİ BOX QUANTITY
119112	½" x 17	4	50	600
119114	½" x 22	4	50	500
119122	¾" x 17	4	50	550
119124	¾" x 22	4	50	450

### MİNİ VANA ERKEK - YASSI DAMLAMA

MINI VALVE MALE - TAPE

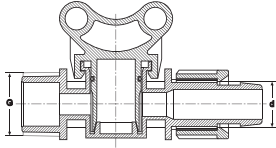

KOD CODE	EBAT / SIZE d x d <sub>1</sub>	BASINÇ DEĞERİ PRESSURE VALUE PN	AMBALAJ ADEDİ PACKING QUANTITY	KOLİ ADEDİ BOX QUANTITY
119222	16 x 17	4	50	600
119224	16 x 22	4	50	500
119242	20 x 17	4	50	600
119244	20 x 22	4	50	450
119254	25 x 22	4	50	450

### MİNİ VANA KURTAĞZI - YASSI DAMLAMA

MINI VALVE BARBED - TAPE

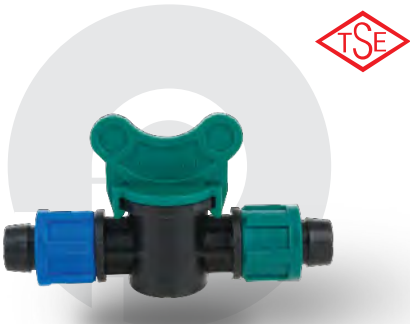
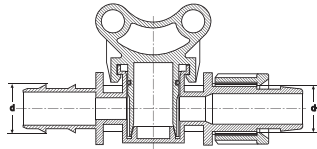

KOD CODE	EBAT / SIZE d x d <sub>1</sub>	BASINÇ DEĞERİ PRESSURE VALUE PN	AMBALAJ ADEDİ PACKING QUANTITY	KOLİ ADEDİ BOX QUANTITY
119322	16 x 17	4	50	550
119324	16 x 22	4	50	450
119342	20 x 17	4	50	500
119344	20 x 22	4	50	400

### MİNİ VANA DAMLAMA - YASSI DAMLAMA

MINI VALVE DRIPLINE - TAPE

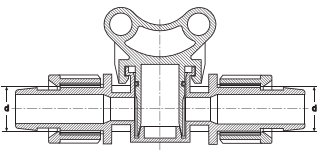

## YÜZÜKLÜ YASSI DAMLA SULAMA MİNİ VANALAR (DN 8) / TAPE DRIP VALVES WITH RING (DN 8)

KOD CODE	EBAT / SIZE d x d	BASINÇ DEĞERİ PRESSURE VALUE PN	AMBALAJ ADEDİ PACKING QUANTITY	KOLİ ADEDİ BOX QUANTITY
119422	17 x 17	4	50	600
119444	22 x 22	4	50	400



**MİNİ VANA YASSI DAMLAMA**  
MINI VALVE TAPE DRIP

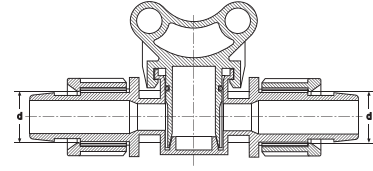

KOD CODE	EBAT / SIZE d x c	BASINÇ DEĞERİ PRESSURE VALUE PN	AMBALAJ ADEDİ PACKING QUANTITY	KOLİ ADEDİ BOX QUANTITY
119522	17 x 16	4	50	650



**MİNİ VANA YÜZÜKLÜ YASSI - GROMMET**  
MINI VALVE TAPE (WITH RING) - GROMMET

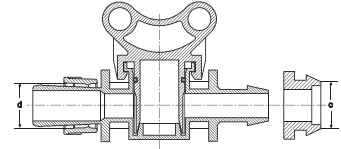

KOD CODE	EBAT / SIZE d x c	BASINÇ DEĞERİ PRESSURE VALUE PN	AMBALAJ ADEDİ PACKING QUANTITY	KOLİ ADEDİ BOX QUANTITY
119523	17 x 16	4	50	600



**MİNİ VANA YÜZÜKLÜ YASSI - GROMMET - D.Ç:18mm**  
MINI VALVE TAPE (WITH RING) - GROMMET - DD:18mm

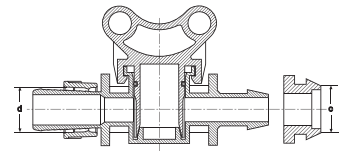

D.Ç:Delme Çapı / DD:Drilling Diameter

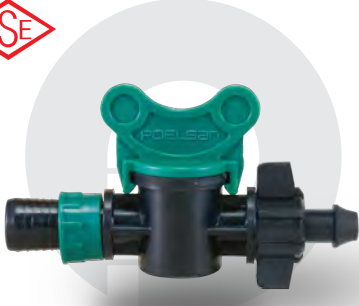

KOD CODE	EBAT / SIZE d	BASINÇ DEĞERİ PRESSURE VALUE PN	AMBALAJ ADEDİ PACKING QUANTITY	KOLİ ADEDİ BOX QUANTITY
119622	17	4	50	600

**MİNİ VANA YÜZÜKLÜ YASSI - CONTASIZ ÇIKIŞ**  
MINI VALVE TAPE (WITH RING) - OFFTAKE WITHOUT GASKET

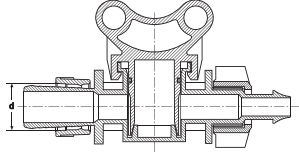

KOD CODE	EBAT / SIZE d x G	BASINÇ DEĞERİ PRESSURE VALUE PN	AMBALAJ ADEDİ PACKING QUANTITY	KOLİ ADEDİ BOX QUANTITY
119722	17 x 1/2"	4	50	650

**MİNİ VANA YÜZÜKLÜ YASSI - ERKEK**  
MINI VALVE TAPE (WITH RING) - MALE

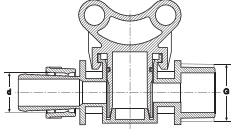

KOD CODE	EBAT / SIZE d x d <sub>1</sub>	BASINÇ DEĞERİ PRESSURE VALUE PN	AMBALAJ ADEDİ PACKING QUANTITY	KOLİ ADEDİ BOX QUANTITY
119822	17 x 16	4	50	650

**MİNİ VANA YÜZÜKLÜ YASSI - KURTAĞZI**  
MINI VALVE TAPE (WITH RING) - BARBED

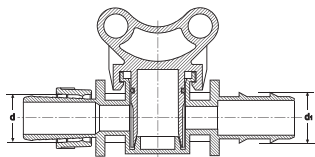



KOD CODE	EBAT / SIZE d x d	BASINÇ DEĞERİ PRESSURE VALUE PN	AMBALAJ ADEDİ PACKING QUANTITY	KOLİ ADEDİ BOX QUANTITY
119922	17 x 17	4	50	650



**MİNİ VANA YÜZÜKLÜ YASSI**  
MINI VALVE TAPE (WITH RING)

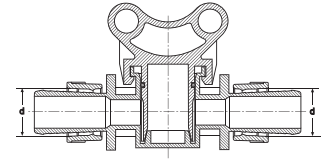

## MINİ VANA (DN 15)

MINI VALVE (DN 15)

### Özellikler

- + Su geçiş çapı 15 mm.
- + Darbelere karşı dayanıklı, yüksek kaliteli polipropilen hammaddeden üretilmiştir.
- + Uzun mesafe damlama ve yassı borular için geniş su geçişi sağlar.
- + Sulama sisteminizi kolayca açıp kapayarak kontrol etmenizi sağlar.
- + UV ışınlarını geçirmediği için yosunlanmaya ve bakteri üremesine izin vermez.
- + İç yüzeyleri homojen ve gözeneksizdir.
- + Suyun kokusunu ve tadını değiştirebilecek zararlı bileşikler içermez.

### Specifications

- + Water pass diameter 15 mm.
- + It has been produced from high quality polipropilen raw material and it has resistance to impact.
- + It allows a wide water pass for long distance dripline, and tape pipes.
- + It supplies an easy on-off control on the irrigation system.
- + They prevent alga and bacteria forming due to UV proof (ultraviolet beam) structure.
- + It has a homogeneous and non-porous inner surface.
- + It does not contain any harmful compounds which can change the taste or the smell of the water.

**GARANTİ VERİLEN BASINÇ DEĞERİ** : PN 2  
**GUARANTEED PRESSURE VALUE** : PN 2



TS EN ISO 9261

### KULLANIM ALANLARI

- + Tarımsal Sulama
- + Peyzaj Sektörü
- + Seralar

### INSTALLATION AREAS

- + Agricultural Irrigation
- + Landscaping Systems
- + Greenhouses





## DAMLA SULAMA MİNİ VANALAR (DN 15) / DRIPLINE MINI VALVES (DN 15)

KOD CODE	EBAT / SIZE G x G	BASINÇ DEĞERİ PRESSURE VALUE PN	AMBALAJ ADEDİ PACKING QUANTITY	KOLİ ADEDİ BOX QUANTITY
120011	½" x ½"	2	25	300
120021	¾" x ½"	2	25	300
120022	¾" x ¾"	2	25	300
120031	1" x ½"	2	25	300
120032	1" x ¾"	2	25	275
120033	1" x 1"	2	25	250
120034	1 ¼" x 1 ¼"	2	25	175



**MİNİ VANA ERKEK**  
MINI VALVE MALE

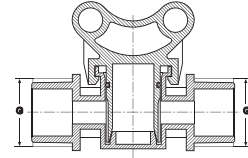

KOD CODE	EBAT / SIZE d x d	BASINÇ DEĞERİ PRESSURE VALUE PN	AMBALAJ ADEDİ PACKING QUANTITY	KOLİ ADEDİ BOX QUANTITY
120044	20 x 20	2	25	200
120054	25 x 20	2	25	175
120055	25 x 25	2	25	150
120066	32 x 32	2	10	100



**MİNİ VANA KİLİTLİ BAĞLANTI**  
MINI VALVE LOCK TYPE

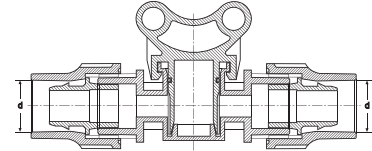

KOD CODE	EBAT / SIZE d x G	BASINÇ DEĞERİ PRESSURE VALUE PN	AMBALAJ ADEDİ PACKING QUANTITY	KOLİ ADEDİ BOX QUANTITY
120121	20 x ½"	2	25	250
120122	20 x ¾"	2	25	250
120131	25 x ½"	2	25	200
120132	25 x ¾"	2	25	200
120133	25 x 1"	2	25	200



**MİNİ VANA KİLİTLİ BAĞLANTI - ERKEK**  
MINI VALVE LOCK TYPE - MALE

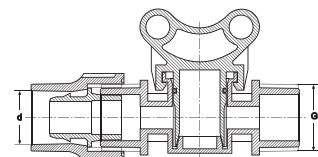

# DAMLA SULAMA MİNİ VANALAR (DN 15) / DRIPLINE MINI VALVES (DN 15)



## MİNİ VANA KİLİTLİ BAĞLANTI - KURTAĞZI

MINI VALVE LOCK TYPE - BARBED

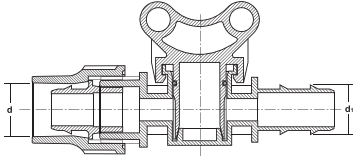

KOD CODE	EBAT / SIZE d x d <sub>1</sub>	BASINÇ DEĞERİ PRESSURE VALUE PN	AMBALAJ ADEDİ PACKING QUANTITY	KOLİ ADEDİ BOX QUANTITY
120142	20 x 20	2	25	250
120143	20 x 25	2	25	225
120152	25 x 20	2	25	175
120153	25 x 25	2	25	175



## MİNİ VANA KİLİTLİ BAĞLANTI - GROMMET

MINI VALVE LOCK TYPE - GROMMET

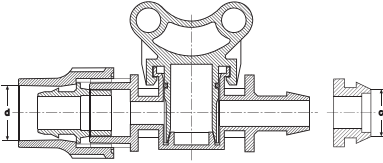

KOD CODE	EBAT / SIZE d x c	BASINÇ DEĞERİ PRESSURE VALUE PN	AMBALAJ ADEDİ PACKING QUANTITY	KOLİ ADEDİ BOX QUANTITY
120172	20 x 20	2	25	200
120182	25 x 20	2	25	200



## MİNİ VANA KURTAĞZI

MINI VALVE BARBED

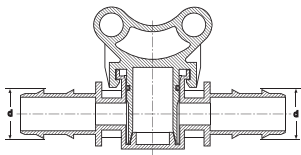

KOD CODE	EBAT / SIZE d x d	BASINÇ DEĞERİ PRESSURE VALUE PN	AMBALAJ ADEDİ PACKING QUANTITY	KOLİ ADEDİ BOX QUANTITY
120222	20 x 20	2	25	300
120232	25 x 20	2	25	275
120233	25 x 25	2	25	250

## DAMLA SULAMA MİNİ VANALAR (DN 15) / DRILINE MINI VALVES (DN 15)

KOD CODE	EBAT / SIZE d x G	BASINÇ DEĞERİ PRESSURE VALUE PN	AMBALAJ ADEDİ PACKING QUANTITY	KOLİ ADEDİ BOX QUANTITY
120321	20 x ½"	2	25	300
120322	20 x ¾"	2	25	300
120323	20 x 1"	2	25	250
120331	25 x ½"	2	25	275
120332	25 x ¾"	2	25	275
120333	25 x 1"	2	25	250



**MİNİ VANA KURTAĞZI - ERKEK**  
MINI VALVE BARBED - MALE

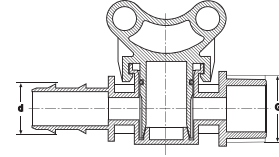

KOD CODE	EBAT / SIZE d x c	BASINÇ DEĞERİ PRESSURE VALUE PN	AMBALAJ ADEDİ PACKING QUANTITY	KOLİ ADEDİ BOX QUANTITY
120382	25 x 20	2	25	275



**MİNİ VANA KURTAĞZI - GROMMET**  
MINI VALVE BARBED - GROMMET

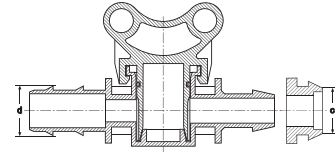

KOD CODE	EBAT / SIZE d x d	BASINÇ DEĞERİ PRESSURE VALUE PN	AMBALAJ ADEDİ PACKING QUANTITY	KOLİ ADEDİ BOX QUANTITY
120422	20 x 20	2	25	250

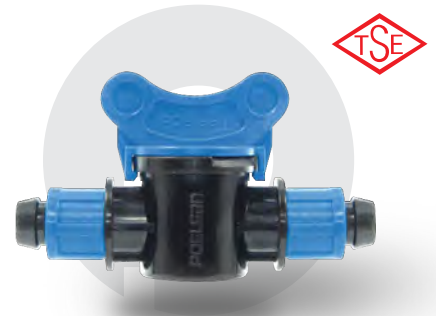

**MİNİ VANA DAMLAMA**  
MINI VALVE DRILINE

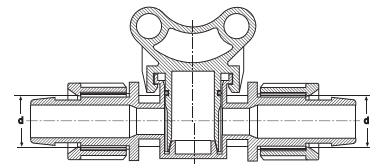

# DAMLA SULAMA MİNİ VANALAR (DN 15) / DRIPLINE MINI VALVES (DN 15)



**MİNİ VANA DAMLAMA - ERKEK**  
MINI VALVE DRIPLINE - MALE

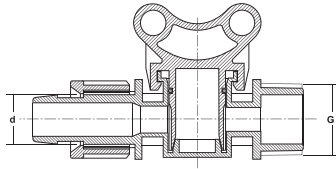

KOD CODE	EBAT / SIZE d x G	BASINÇ DEĞERİ PRESSURE VALUE PN	AMBALAJ ADEDİ PACKING QUANTITY	KOLİ ADEDİ BOX QUANTITY
120521	20 x 1/2"	2	25	250
120522	20 x 3/4"	2	25	250



**MİNİ VANA DAMLAMA -KURTAĞZI**  
MINI VALVE DRIPLINE - BARBED

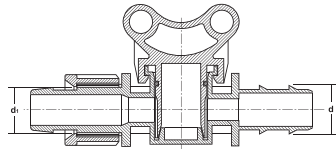

KOD CODE	EBAT / SIZE d x G	BASINÇ DEĞERİ PRESSURE VALUE PN	AMBALAJ ADEDİ PACKING QUANTITY	KOLİ ADEDİ BOX QUANTITY
120622	20 x 20	2	25	250



**MİNİ VANA DAMLAMA - GROMMET**  
MINI VALVE DRIPLINE - GROMMET

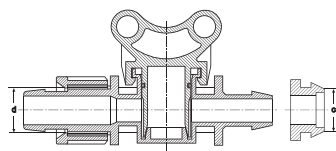

KOD CODE	EBAT / SIZE d x G	BASINÇ DEĞERİ PRESSURE VALUE PN	AMBALAJ ADEDİ PACKING QUANTITY	KOLİ ADEDİ BOX QUANTITY
120672	20 x 20	2	25	250

## YASSI DAMLA SULAMA MİNİ VANALAR (DN 15) / TAPE MINI VALVES (DN 15)

KOD CODE	EBAT / SIZE d x d	BASINÇ DEĞERİ PRESSURE VALUE PN	AMBALAJ ADEDİ PACKING QUANTITY	KOLİ ADEDİ BOX QUANTITY
120722	22 x 22	2	25	200
120733	25 x 25	2	25	200



**MİNİ VANA YASSI DAMLAMA**  
MINI VALVE TAPE

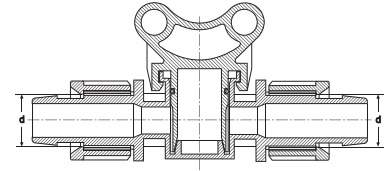

KOD CODE	EBAT / SIZE d x G	BASINÇ DEĞERİ PRESSURE VALUE PN	AMBALAJ ADEDİ PACKING QUANTITY	KOLİ ADEDİ BOX QUANTITY
120821	22 x 1/2"	2	25	250
120822	22 x 3/4"	2	25	250
120831	25 x 1/2"	2	25	225
120832	25 x 3/4"	2	25	225
120833	25 x 1"	2	25	200



**MİNİ VANA YASSI DAMLAMA - ERKEK**  
MINI VALVE TAPE - MALE

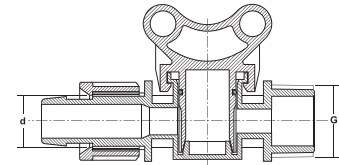

KOD CODE	EBAT / SIZE d <sub>1</sub> x d	BASINÇ DEĞERİ PRESSURE VALUE PN	AMBALAJ ADEDİ PACKING QUANTITY	KOLİ ADEDİ BOX QUANTITY
120922	22 x 20	2	25	250
120923	22 x 25	2	25	225
120932	25 x 20	2	25	225
120933	25 x 25	2	25	225



**MİNİ VANA YASSI DAMLAMA - KURTAĞZI**  
MINI VALVE TAPE - BARBED

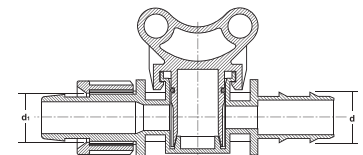

## YASSI DAMLA SULAMA MİNİ VANALAR (DN 15) / TAPE MINI VALVES (DN 15)



KOD CODE	EBAT / SIZE d x c	BASINÇ DEĞERİ PRESSURE VALUE PN	AMBALAJ ADEDİ PACKING QUANTITY	KOLİ ADEDİ BOX QUANTITY
120972	22 x 20	2	25	225
120982	25 x 20	2	25	225

### MİNİ VANA YASSI DAMLAMA - GROMMET MINI VALVE TAPE - GROMMET

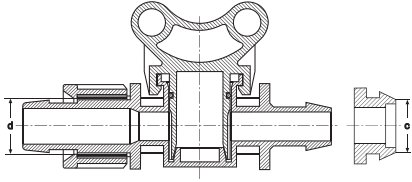



# MINİ VANALAR (DN 8)

## MINI VALVES (DN 8)

### DİKKAT EDİLMESİ GEREKEN HUSUSLAR

- + Grommet Conta ile çıkış almak için kullanılacak Grommet Contalı Mini Vana çeşidine göre delik çapı 16 mm veya 20 mm olacak şekilde boru delinmelidir.
- + Contasız Çıkış, Layflat ve Alçak Yoğunluklu Polietilen (AYPE) Borulardan (Düz Damla Sulama Borusu) Ø16 mm ve Ø20 mm Yuvarlak Damla Sulama Borularına çıkış almak için kullanılır. Contasız Çıkış Ucu ile çıkış almak için boru, delik çapı 8 mm olacak şekilde delinmelidir.
- + Mini Vana Contasız Çıkış ürünü, Layflat borulardan, Ø12 mm Spagetti Borulara çıkış almak için kullanılır. Contasız Çıkış Ucu ile çıkış almak için boru, delik çapı 8 mm olacak şekilde delinmelidir.

### POINTS TO TAKE INTO CONSIDERATION

- + For a proper offtake with the Grommet Gasket, the pipe should be punched 16 mm or 20 mm according to the Mini Valve with Grommet Gasket to be used.
- + The items with offtake end without gasket are used for joining the Layflat and Low Density Polyethylene (LDPE) Pipes (Flat Drip Irrigation Pipe) with Round Drip Irrigation Pipes (Ø16 mm & Ø20 mm). For a proper offtake, the pipe should be punched 8 mm.
- + The Mini Valve Offtake without gasket item is used for the connection offtake from Layflat pipes to 12 mm Microtube Pipes with Ø12 mm Microtube Pipes. For a proper offtake, the pipe should be punched 8 mm.

# MINİ VANALAR (DN 15)

## MINI VALVES (DN 15)

### DİKKAT EDİLMESİ GEREKEN HUSUSLAR

- + Grommet Conta ile çıkış almak için kullanılacak Grommet Contalı Mini Vana çeşidine göre delik çapı 20 mm olacak şekilde boru delinmelidir.

### POINTS TO TAKE INTO CONSIDERATION

- + For a proper offtake with the Grommet Gasket, the pipe should be punched 20 mm according to the Mini Valve with Grommet Gasket to be used.

# HAT SONU TAHLİYE VANASI

## AUTOMATIC LINE FLUSH VALVES

### Özellikler

- + Saha koşullarında kolay ve pratik montaj ve demontaj,
- + Uzun ömürlü diyafram dizaynı,
- + Otomatik hat içi temizleme ve kolay bakım,
- + Değişen debi koşullarına karşı güvenli kullanım,
- + Çevre hassasiyetinin ve darbelere karşı dayanımın ön planda olduğu malzeme kullanımı.

### Specifications

- + Easy and practical assembly and disassembly in field conditions,
- + Long life diaphragm design,
- + Automatic inline cleaning and easy maintenance,
- + Safe use against changing flow conditions,
- + The use of materials where environmental sensitivity and resistance to impacts are at the forefront.

#### Otomatik Kapama Özelliği

Auto-Off Feature

**Max. Çalışma Basıncı** : 4.0 Bar

Max. Working Pressure :

**Min. Çalışma Basıncı** : 1.0 Bar

Min. Working Pressure :

**Min. Debi**

Min. Flow

: 2.3 m<sup>3</sup>/s

:

#### KULLANIM ALANLARI

- + Tarımsal Sulama
- + Peyzaj Sektörü
- + Seralar

#### INSTALLATION AREAS

- + Agricultural Irrigation
- + Landscaping Systems
- + Greenhouses



# HAT SONU TAHLİYE VANASI / AUTOMATIC LINE FLUSH VALVES

KOD CODE	EBAT / SIZE D	BASINÇ DEĞERİ PRESSURE VALUE PN	AMBALAJ ADEDİ PACKING QUANTITY	KOLİ ADEDİ BOX QUANTITY
28122	1/2"	4	10	420
28133	3/4"	4	10	400



**HAT SONU TAHLİYE VANASI - ERKEK**  
AUTOMATIC LINE FLUSH VALVE - MALE

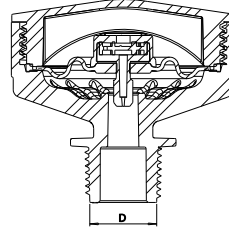

KOD CODE	EBAT / SIZE D	BASINÇ DEĞERİ PRESSURE VALUE PN	AMBALAJ ADEDİ PACKING QUANTITY	KOLİ ADEDİ BOX QUANTITY
28211	16	4	10	340
28222	20	4	10	320



**HAT SONU TAHLİYE VANASI - KİLİTLİ BAĞLANTI**  
AUTOMATIC LINE FLUSH VALVE - LOCK TYPE

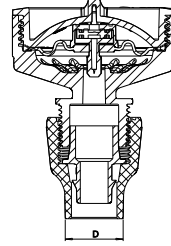

KOD CODE	EBAT / SIZE D	BASINÇ DEĞERİ PRESSURE VALUE PN	AMBALAJ ADEDİ PACKING QUANTITY	KOLİ ADEDİ BOX QUANTITY
28311	16	4	10	400
28322	20	4	10	400



**HAT SONU TAHLİYE VANASI - KURTAĞZI**  
AUTOMATIC LINE FLUSH VALVE - BARBED

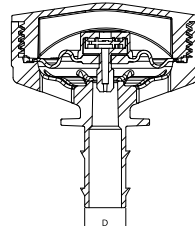

# HAT SONU TAHLİYE VANASI

## AUTOMATIC LINE FLUSH VALVES

### DİKKAT EDİLMESİ GEREKEN HUSUSLAR

- + Tahliye vana içerisindeki damlatıcı tıkanmaması için temiz tutulmalıdır.
- + Diyafram conta temizlenirken montaj yönüne dikkat edilmelidir.
- + Hat sonu tahliye vanasının düzenli olarak kontrol edilmesi ve bakımı önemlidir.
- + Damlama sisteminde kullanılacak vana sayısı, su kapasitesini etkilediği için projede pompa seçimine dikkat edilmelidir.

### POINTS TO TAKE INTO CONSIDERATION

- + The dripper inside the automatic line flush valve must be kept clean so that it does not clog.
- + While cleaning the diaphragm seal, attention should be paid to the mounting direction.
- + It is important to regularly check and maintain the automatic line flush valve.
- + Since the number of valves to be used in the drip system affects the water capacity, attention should be paid to pump selection in the project.

## KİLİTLİ BAĞLANTI ELEMANLARI

### LOCK TYPE FITTINGS

### Özellikler

- + Darbelere karşı dayanıklı, yüksek kaliteli polipropilèn hammaddeden üretilmiştir.
- + UV ışınlarını geçirmediği için yosunlanmaya ve bakteri üremesine izin vermez.
- + İç yüzeyleri homojen ve gözeneksizdir.
- + Suyun kokusunu ve tadını değiştirebilecek zararlı bileşikler içermez.

### Specifications

- + It has been produced from high quality polypropylene raw material and it has resistance to impact.
- + They prevent alga and bacteria forming due to UV proof (ultraviolet beam) structure.
- + It has a homogeneous and non-porous inner surface.
- + It does not contain any harmful compounds which can change the taste or the smell of the water.

**GARANTİ VERİLEN BASINÇ DEĞERİ : PN 6**  
**GUARANTEED PRESSURE VALUE : PN 6**

### KULLANIM ALANLARI

- + Peyzaj Sektörü
- + Tarımsal Sulama
- + Seralar

### INSTALLATION AREAS

- + Landscaping Systems
- + Agricultural Irrigation
- + Greenhouses



**TS EN ISO 9261**



# KİLİTLİ BAĞLANTI ELEMANLARI / LOCK TYPE FITTINGS



**KİLİTLİ BAĞLANTI ERKEK**  
LOCK TYPE MALE

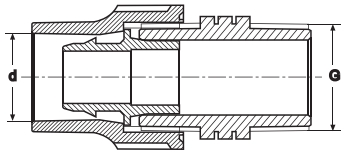

KOD CODE	EBAT / SIZE d x G	BASINÇ DEĞERİ PRESSURE VALUE PN	AMBALAJ ADEDİ PACKING QUANTITY	KOLİ ADEDİ BOX QUANTITY
<b>12121</b>	<b>16 x 1/2"</b>	<b>6</b>	<b>50</b>	<b>900</b>
12122	16 x 3/4"	6	50	800
<b>12123</b>	<b>16 x 1"</b>	<b>6</b>	<b>50</b>	<b>650</b>
12124	16 x 1 1/4"	6	50	350
<b>12141</b>	<b>20 x 1/2"</b>	<b>6</b>	<b>50</b>	<b>800</b>
12142	20 x 3/4"	6	50	700
<b>12143</b>	<b>20 x 1"</b>	<b>6</b>	<b>50</b>	<b>600</b>
12144	20 x 1 1/4"	6	50	350
<b>12151</b>	<b>25 x 1/2"</b>	<b>6</b>	<b>25</b>	<b>450</b>
12152	25 x 3/4"	6	25	450
<b>12153</b>	<b>25 x 1"</b>	<b>6</b>	<b>25</b>	<b>450</b>
12154	25 x 1 1/4"	6	25	300
<b>12161</b>	<b>32 x 1/2"</b>	<b>6</b>	<b>25</b>	<b>275</b>
12162	32 x 3/4"	6	25	275
<b>12163</b>	<b>32 x 1"</b>	<b>6</b>	<b>25</b>	<b>250</b>
12164	32 x 1 1/4"	6	25	225



**KİLİTLİ BAĞLANTI DIŞI**  
LOCK TYPE FEMALE

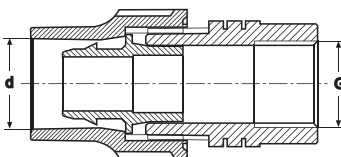

KOD CODE	EBAT / SIZE d x G	BASINÇ DEĞERİ PRESSURE VALUE PN	AMBALAJ ADEDİ PACKING QUANTITY	KOLİ ADEDİ BOX QUANTITY
<b>12221</b>	<b>16 x 1/2"</b>	<b>6</b>	<b>50</b>	<b>900</b>
12222	16 x 3/4"	6	50	700
<b>12223</b>	<b>16 x 1"</b>	<b>6</b>	<b>50</b>	<b>450</b>
12241	20 x 1/2"	6	50	900
<b>12242</b>	<b>20 x 3/4"</b>	<b>6</b>	<b>50</b>	<b>700</b>
12243	20 x 1"	6	50	450
<b>12251</b>	<b>25 x 1/2"</b>	<b>6</b>	<b>25</b>	<b>450</b>
12252	25 x 3/4"	6	25	550
<b>12253</b>	<b>25 x 1"</b>	<b>6</b>	<b>25</b>	<b>375</b>
12261	32 x 1/2"	6	25	275
<b>12262</b>	<b>32 x 3/4"</b>	<b>6</b>	<b>25</b>	<b>250</b>
12263	32 x 1"	6	25	300



# KİLİTLİ BAĞLANTI ELEMANLARI / LOCK TYPE FITTINGS

KOD CODE	EBAT / SIZE d x d	BASINÇ DEĞERİ PRESSURE VALUE PN	AMBALAJ ADEDİ PACKING QUANTITY	KOLİ ADEDİ BOX QUANTITY
<b>12322</b>	<b>16 x 16</b>	<b>6</b>	<b>50</b>	<b>550</b>
12342	20 x 16	6	50	550
<b>12344</b>	<b>20 x 20</b>	<b>6</b>	<b>50</b>	<b>550</b>
12352	25 x 16	6	25	350
<b>12354</b>	<b>25 x 20</b>	<b>6</b>	<b>25</b>	<b>350</b>
12355	25 x 25	6	25	300
<b>12362</b>	<b>32 x 16</b>	<b>6</b>	<b>15</b>	<b>210</b>
12364	32 x 20	6	15	210
<b>12365</b>	<b>32 x 25</b>	<b>6</b>	<b>15</b>	<b>210</b>
12366	32 x 32	6	15	165



**KİLİTLİ BAĞLANTI MANŞON**  
LOCK TYPE COUPLING

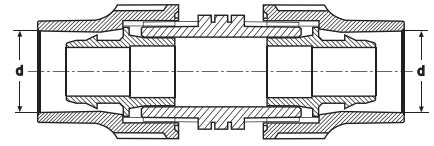

KOD CODE	EBAT / SIZE d x d x d	BASINÇ DEĞERİ PRESSURE VALUE PN	AMBALAJ ADEDİ PACKING QUANTITY	KOLİ ADEDİ BOX QUANTITY
<b>12422</b>	<b>16 x 16 x 16</b>	<b>6</b>	<b>25</b>	<b>300</b>
12424	16 x 20 x 16	6	25	275
<b>12425</b>	<b>16 x 25 x 16</b>	<b>6</b>	<b>25</b>	<b>200</b>
12442	20 x 16 x 20	6	25	275
<b>12444</b>	<b>20 x 20 x 20</b>	<b>6</b>	<b>25</b>	<b>275</b>
12445	20 x 25 x 20	6	25	225
<b>12452</b>	<b>25 x 16 x 25</b>	<b>6</b>	<b>15</b>	<b>180</b>
12454	25 x 20 x 25	6	15	165
<b>12455</b>	<b>25 x 25 x 25</b>	<b>6</b>	<b>15</b>	<b>150</b>
12462	32 x 16 x 32	6	10	100
<b>12464</b>	<b>32 x 20 x 32</b>	<b>6</b>	<b>10</b>	<b>100</b>
12465	32 x 25 x 32	6	10	100
<b>12466</b>	<b>32 x 32 x 32</b>	<b>6</b>	<b>10</b>	<b>90</b>



**KİLİTLİ BAĞLANTI TE**  
LOCK TYPE TEE

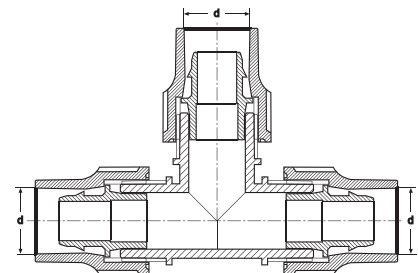

# KİLİTLİ BAĞLANTI ELEMANLARI / LOCK TYPE FITTINGS



**KİLİTLİ BAĞLANTI ERKEK TE**  
LOCK TYPE MALE TEE

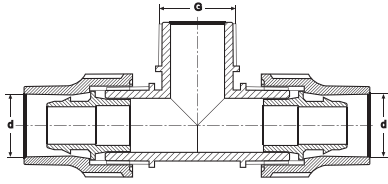

KOD CODE	EBAT / SIZE d x G x d	BASINÇ DEĞERİ PRESSURE VALUE PN	AMBALAJ ADEDİ PACKING QUANTITY	KOLİ ADEDİ BOX QUANTITY
<b>12521</b>	<b>16 x ½" x 16</b>	<b>6</b>	<b>25</b>	<b>350</b>
12522	16 x ¾" x 16	6	25	350
<b>12523</b>	<b>16 x 1" x 16</b>	<b>6</b>	<b>25</b>	<b>300</b>
12541	20 x ½" x 20	6	25	350
<b>12542</b>	<b>20 x ¾" x 20</b>	<b>6</b>	<b>25</b>	<b>300</b>
12543	20 x 1" x 20	6	25	300
<b>12551</b>	<b>25 x ½" x 25</b>	<b>6</b>	<b>15</b>	<b>210</b>
12552	25 x ¾" x 25	6	15	210
<b>12553</b>	<b>25 x 1" x 25</b>	<b>6</b>	<b>15</b>	<b>210</b>
12561	32 x ½" x 32	6	10	120
<b>12562</b>	<b>32 x ¾" x 32</b>	<b>6</b>	<b>10</b>	<b>110</b>
12563	32 x 1" x 32	6	10	110
<b>12564</b>	<b>32 x 1 ¼" x 32</b>	<b>6</b>	<b>10</b>	<b>100</b>



**KİLİTLİ BAĞLANTI DIŞI TE**  
LOCK TYPE FEMALE TEE

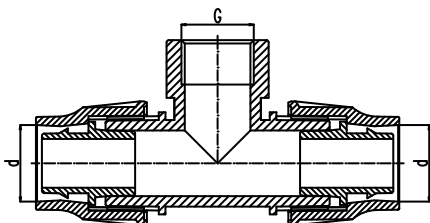

KOD CODE	EBAT / SIZE d x G x d	BASINÇ DEĞERİ PRESSURE VALUE PN	AMBALAJ ADEDİ PACKING QUANTITY	KOLİ ADEDİ BOX QUANTITY
<b>12621</b>	<b>16 x ½" x 16</b>	<b>6</b>	<b>25</b>	<b>300</b>
12622	16 x ¾" x 16	6	25	300
<b>12623</b>	<b>16 x 1" x 16</b>	<b>6</b>	<b>25</b>	<b>275</b>
12641	20 x ½" x 20	6	25	300
<b>12642</b>	<b>20 x ¾" x 20</b>	<b>6</b>	<b>25</b>	<b>275</b>
12643	20 x 1" x 20	6	25	250
<b>12651</b>	<b>25 x ½" x 25</b>	<b>6</b>	<b>15</b>	<b>210</b>
12652	25 x ¾" x 25	6	15	180
<b>12653</b>	<b>25 x 1" x 25</b>	<b>6</b>	<b>15</b>	<b>180</b>
12662	32 x ¾" x 32	6	10	120
<b>12663</b>	<b>32 x 1" x 32</b>	<b>6</b>	<b>10</b>	<b>100</b>

## KİLİTLİ BAĞLANTI ELEMANLARI / LOCK TYPE FITTINGS

KOD CODE	EBAT / SIZE d x d	BASINÇ DEĞERİ PRESSURE VALUE PN	AMBALAJ ADEDİ PACKING QUANTITY	KOLİ ADEDİ BOX QUANTITY
<b>12722</b>	<b>16 x 16</b>	<b>6</b>	<b>50</b>	<b>450</b>
12742	20 x 16	6	50	450
<b>12744</b>	<b>20 x 20</b>	<b>6</b>	<b>50</b>	<b>400</b>
12752	25 x 16	6	25	300
<b>12754</b>	<b>25 x 20</b>	<b>6</b>	<b>25</b>	<b>300</b>
12755	25 x 25	6	25	225
<b>12762</b>	<b>32 x 16</b>	<b>6</b>	<b>15</b>	<b>180</b>
12764	32 x 20	6	15	180
<b>12765</b>	<b>32 x 25</b>	<b>6</b>	<b>15</b>	<b>165</b>
12766	32 x 32	6	15	135



**KİLİTLİ BAĞLANTI DİRSEK**  
LOCK TYPE ELBOW

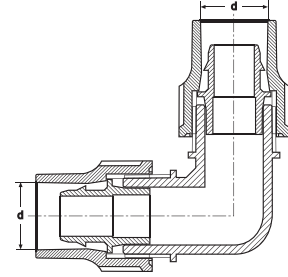

KOD CODE	EBAT / SIZE d x G	BASINÇ DEĞERİ PRESSURE VALUE PN	AMBALAJ ADEDİ PACKING QUANTITY	KOLİ ADEDİ BOX QUANTITY
<b>12821</b>	<b>16 x 1/2"</b>	<b>6</b>	<b>50</b>	<b>650</b>
12822	16 x 3/4"	6	50	600
<b>12823</b>	<b>16 x 1"</b>	<b>6</b>	<b>50</b>	<b>500</b>
12824	16 x 1 1/4"	6	50	300
<b>12841</b>	<b>20 x 1/2"</b>	<b>6</b>	<b>50</b>	<b>600</b>
12842	20 x 3/4"	6	50	600
<b>12843</b>	<b>20 x 1"</b>	<b>6</b>	<b>50</b>	<b>500</b>
12844	20 x 1 1/4"	6	50	300
<b>12851</b>	<b>25 x 1/2"</b>	<b>6</b>	<b>25</b>	<b>375</b>
12852	25 x 3/4"	6	25	400
<b>12853</b>	<b>25 x 1"</b>	<b>6</b>	<b>25</b>	<b>325</b>
12854	25 x 1 1/4"	6	25	225
<b>12861</b>	<b>32 x 1/2"</b>	<b>6</b>	<b>15</b>	<b>210</b>
12862	32 x 3/4"	6	15	180
<b>12863</b>	<b>32 x 1"</b>	<b>6</b>	<b>15</b>	<b>210</b>
12864	32 x 1 1/4"	6	15	180



**KİLİTLİ BAĞLANTI ERKEK DİRSEK**  
LOCK TYPE MALE ELBOW

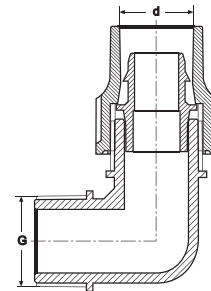

# KİLİTLİ BAĞLANTI ELEMANLARI / LOCK TYPE FITTINGS



**KİLİTLİ BAĞLANTI DIŞI DİRSEK**  
LOCK TYPE FEMALE ELBOW

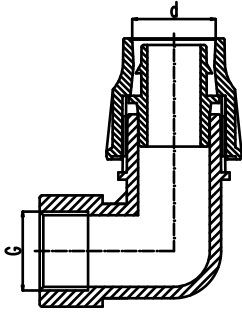

KOD CODE	EBAT / SIZE d x G	BASINÇ DEĞERİ PRESSURE VALUE PN	AMBALAJ ADEDİ PACKING QUANTITY	KOLİ ADEDİ BOX QUANTITY
<b>12921</b>	<b>16 x ½"</b>	<b>6</b>	<b>50</b>	<b>500</b>
12922	16 x ¾"	6	50	450
<b>12923</b>	<b>16 x 1"</b>	<b>6</b>	<b>50</b>	<b>400</b>
12941	20 x ½"	6	50	500
<b>12942</b>	<b>20 x ¾"</b>	<b>6</b>	<b>50</b>	<b>450</b>
12943	20 x 1"	6	50	400
<b>12951</b>	<b>25 x ½"</b>	<b>6</b>	<b>25</b>	<b>300</b>
12952	25 x ¾"	6	25	300
<b>12953</b>	<b>25 x 1"</b>	<b>6</b>	<b>25</b>	<b>275</b>
12962	32 x ¾"	6	15	180
<b>12963</b>	<b>32 x 1"</b>	<b>6</b>	<b>15</b>	<b>180</b>
12964	32 x 1¼"	6	15	150



**KİLİTLİ BAĞLANTI KÖR TAPA**  
LOCK TYPE END CAP

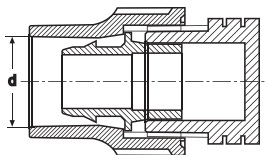

KOD CODE	EBAT / SIZE d	BASINÇ DEĞERİ PRESSURE VALUE PN	AMBALAJ ADEDİ PACKING QUANTITY	KOLİ ADEDİ BOX QUANTITY
<b>13022</b>	<b>16</b>	<b>6</b>	<b>50</b>	<b>1000</b>
13044	20	6	50	900
<b>13055</b>	<b>25</b>	<b>6</b>	<b>25</b>	<b>550</b>
13066	32	6	25	300

# KİLİTLİ BAĞLANTI ELEMANLARI / LOCK TYPE FITTINGS

KOD CODE	EBAT / SIZE d x d <sub>1</sub>	BASINÇ DEĞERİ PRESSURE VALUE PN	AMBALAJ ADEDİ PACKING QUANTITY	KOLİ ADEDİ BOX QUANTITY
130922	16 x 16	6	50	900
130942	20 x 16	6	50	800
130944	20 x 20	6	50	700



**KİLİTLİ BAĞLANTI KURTAĞZI**  
LOCK TYPE BARBED

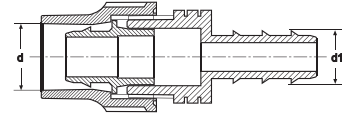

KOD CODE	EBAT / SIZE d	GÖVDE EBADI BODY SIZE	AMBALAJ ADEDİ PACKING QUANTITY	KOLİ ADEDİ BOX QUANTITY
13072	16	¾"	100	1800
13074	20	¾"	100	1500
13075	25	1"	50	800
13076	32	1¼"	50	450



**KİLİTLİ BAĞLANTI SOMUNU**  
LOCK TYPE NUT

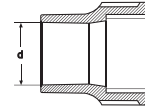

KOD CODE	EBAT / SIZE d	GÖVDE EBADI BODY SIZE	AMBALAJ ADEDİ PACKING QUANTITY	KOLİ ADEDİ BOX QUANTITY
13082	16	¾"	200	5200
13084	20	¾"	200	4800
13085	25	1"	100	2400
13086	32	1¼"	100	1200



**KİLİTLİ BAĞLANTI UCU**  
LOCK TYPE INSERT

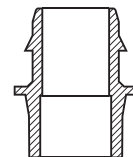

# KİLİTLİ BAĞLANTI ELEMANLARI

## LOCK TYPE FITTINGS

### DİKKAT EDİLMESİ GEREKEN HUSUSLAR

- + Ø16 mm, Ø20 mm, Ø25 mm, Ø32 mm Alçak Yoğunluklu Polietilen (AYPE) Borularda (Deliksiz kör boru) kullanılır.
- + Ø16 mm için et kalınlığı minimum 0.8 mm'ye kadar ve Ø20 mm için et kalınlığı minimum 1.0 mm'ye kadar olan Yuvarlak Damla Sulama Borularında da kullanılabilir.
- + Ø16 mm, Ø20 mm, Ø25 mm, Ø 32 mm olan PVC Bahçe Sulama Hortumlarının Ekleme Parçaları olarak da kullanılabilir.

### POINTS TO TAKE INTO CONSIDERATION

- + Used in Ø16 mm, Ø20 mm, Ø25 mm, Ø32 mm Low Density Polyethylene (LDPE) Pipes (Flat Drip Irrigation Pipe).
- + Also might be used with Round Drip Irrigation Pipe with Ø16 mm diameter up to 0.8 mm of wall thickness and Ø20 mm diameter with 1.0 mm of wall thickness.
- + Also might be used as Fittings for Ø16 mm, Ø20 mm, Ø25 mm, Ø32 mm Garden Hoses made of PVC.



## DAMLA SULAMA KURTAĞZI

### DRIPLINE BARBED FITTINGS

## Özellikler

- + Darbelere karşı dayanıklı, yüksek kaliteli polipropilen hammaddeden üretilmiştir.
- + Ø16 mm ve Ø20 mm Alçak Yoğunluklu Polietilen (AYPE) Borularda (Düz Damla Sulama Borusu) kullanılır.
- + Ø16 mm ve Ø20 mm Yuvarlak Damla Sulama Borularında kullanılır.
- + UV ışınlarını geçirmediği için yosunlanmaya ve bakteri üremesine izin vermez.
- + İç yüzeyleri homojen ve gözeneksizdir.
- + Suyun kokusunu ve tadını değiştirebilecek zararlı bileşikler içermez.

## Specifications

- + It has been produced from high quality polypropylene raw material and it has resistance to impact.
- + Used with Ø16 mm and Ø20 mm Low Density Polyethylene (LDPE) Pipes (Flat Drip Irrigation Pipe).
- + Used with Ø16 mm and Ø20 mm Drip Irrigation Circular Pipe.
- + They prevent alga and bacteria forming due to UV proof (ultraviolet beam) structure.
- + It has a homogeneous and non-porous inner surface.
- + It does not contain any harmful compounds which can change the taste or the smell of the water.



### KULLANIM ALANLARI

- + Tarımsal Sulama
- + Peyzaj Sektörü
- + Seralar

### INSTALLATION AREAS

- + Agricultural Irrigation
- + Landscaping Systems
- + Greenhouses

# DAMLA SULAMA KURTAĞZI / DRIPLINE BARBED FITTINGS



**KURTAĞZI NİPEL**  
BARBED NIPPLE

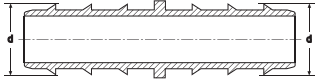

KOD CODE	EBAT / SIZE d x d	AMBALAJ ADEDİ PACKING QUANTITY	KOLİ ADEDİ BOX QUANTITY
15122	16 x 16	100	3800
15142	20 x 16	100	2200
15144	20 x 20	100	2000



**KURTAĞZI - ERKEK NİPEL**  
BARBED - MALE NIPPLE

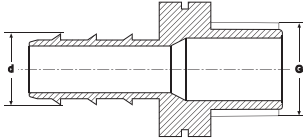

KOD CODE	EBAT / SIZE d x G	AMBALAJ ADEDİ PACKING QUANTITY	KOLİ ADEDİ BOX QUANTITY
15221	16 x 1/2"	100	1800
15222	16 x 3/4"	100	1600
15241	20 x 1/2"	100	1500
15242	20 x 3/4"	100	1400
15252	25 x 3/4"	100	800
15253	25 x 1"	100	800
15263	32 x 1"	100	600
15274	40 x 1 1/4"	50	300
15285	50 x 1 1/2"	25	200
15296	63 x 2"	15	120



**KURTAĞZI TE**  
BARBED TEE

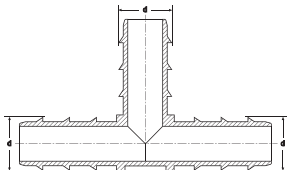

KOD CODE	EBAT / SIZE d x d x d	AMBALAJ ADEDİ PACKING QUANTITY	KOLİ ADEDİ BOX QUANTITY
15322	16 x 16 x 16	100	1600
15324	16 x 20 x 16	100	1300
15342	20 x 16 x 20	100	900
15344	20 x 20 x 20	100	800

## DAMLA SULAMA KURTAĞZI / DRIPLINE BARBED FITTINGS

KOD CODE	EBAT / SIZE d x G x d	AMBALAJ ADEDİ PACKING QUANTITY	KOLİ ADEDİ BOX QUANTITY
15421	16 x ½" x 16	100	1500
15422	16 x ¾" x 16	100	1200
15441	20 x ½" x 20	100	900
15442	20 x ¾" x 20	100	800
15443	20 x 1" x 20	100	600



**KURTAĞZI - ERKEK TE**  
BARBED - MALE TEE

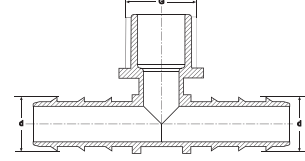

KOD CODE	EBAT / SIZE d x c x d	AMBALAJ ADEDİ PACKING QUANTITY	KOLİ ADEDİ BOX QUANTITY
15466	16 x 16 x 16	100	1400
15468	16 x 20 x 16	100	1200
15488	20 x 20 x 20	100	700



**KURTAĞZI - GROMMET TE**  
BARBED - GROMMET TEE

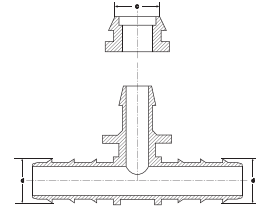

KOD CODE	EBAT / SIZE d x c x d	AMBALAJ ADEDİ PACKING QUANTITY	KOLİ ADEDİ BOX QUANTITY
15467	16 x 16 x 16	100	1300



**KURTAĞZI - GROMMET TE - D.Ç:18mm**  
BARBED - GROMMET TEE - DD:18mm

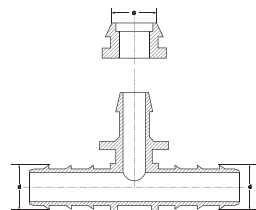

D.Ç:Delme Çapı / DD:Drilling Diameter

# DAMLA SULAMA KURTAĞZI / DRIFLINE BARBED FITTINGS



**KURTAĞZI DİRSEK**  
BARBED ELBOW

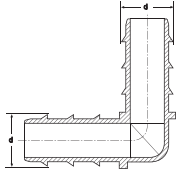

KOD CODE	EBAT / SIZE d x d	AMBALAJ ADEDİ PACKING QUANTITY	KOLİ ADEDİ BOX QUANTITY
15522	16 x 16	100	2800
15544	20 x 20	100	1600



**KURTAĞZI - ERKEK DİRSEK**  
BARBED - MALE ELBOW

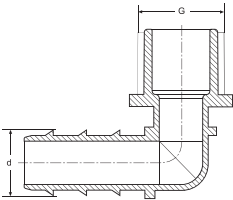

KOD CODE	EBAT / SIZE d x G	AMBALAJ ADEDİ PACKING QUANTITY	KOLİ ADEDİ BOX QUANTITY
15621	16 x 1/2"	100	2200
15622	16 x 3/4"	100	1800
15641	20 x 1/2"	100	1600
15642	20 x 3/4"	100	1300

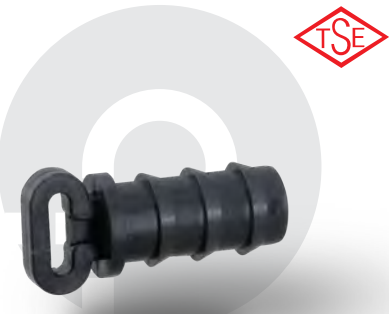

**KURTAĞZI KÖR TAPA**  
BARBED END CAP

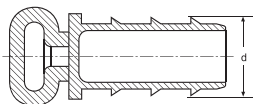

KOD CODE	EBAT / SIZE d	AMBALAJ ADEDİ PACKING QUANTITY	KOLİ ADEDİ BOX QUANTITY
15722	16	100	5000
15744	20	100	2800

# DAMLA SULAMA KURTAĞZI / DRIPLINE BARBED FITTINGS

KOD CODE	EBAT / SIZE d x c	AMBALAJ ADEDİ PACKING QUANTITY	KOLİ ADEDİ BOX QUANTITY
15822	16 x 16	100	2600
15842	20 x 16	100	2200



**KURTAĞZI - GROMMET NİPEL**  
BARBED - GROMMET NIPPLE

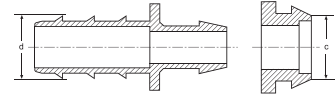

KOD CODE	EBAT / SIZE d x c	AMBALAJ ADEDİ PACKING QUANTITY	KOLİ ADEDİ BOX QUANTITY
15823	16 x 16	100	2400
15843	20 x 16	100	2000



**KURTAĞZI - GROMMET NİPEL - D.Ç:18mm**  
BARBED - GROMMET NIPPLE - DD:18mm

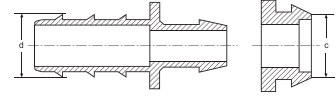

KOD CODE	EBAT / SIZE d	AMBALAJ ADEDİ PACKING QUANTITY	KOLİ ADEDİ BOX QUANTITY
15966	16	100	4500

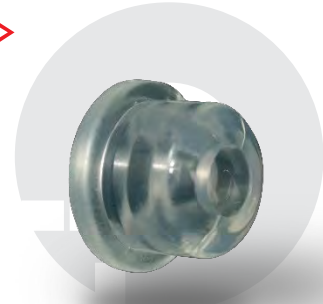

**KURTAĞZI GROMMET CONTA**  
BARBED GROMMET GASKET

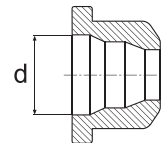

D.Ç:Delme Çapı / DD:Drilling Diameter

# DAMLA SULAMA KURTAĞZI / DRIPLINE BARBED FITTINGS



**BORU KELEPÇESİ**  
PIPE CLIP



KOD CODE	EBAT SIZE-mm	AMBALAJ ADEDİ PACKING QUANTITY	KOLİ ADEDİ BOX QUANTITY
16022	16	500	15000
16044	20	500	10000



**KURTAĞZI ÇOKLU DAĞITIM NİPELİ**  
BARBED MULTICOUPLING NIPPLE

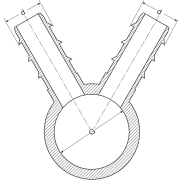

KOD CODE	EBAT / SIZE d x G	AMBALAJ ADEDİ PACKING QUANTITY	KOLİ ADEDİ BOX QUANTITY
15922	2 / 16 x 1"	25	650
15924	2 / 20 x 1"	25	450



**KURTAĞZI ÇOKLU DAĞITIM NİPELİ**  
BARBED MULTICOUPLING NIPPLE

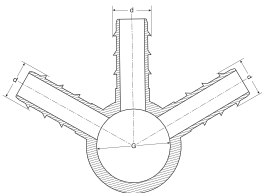

KOD CODE	EBAT / SIZE d x G	AMBALAJ ADEDİ PACKING QUANTITY	KOLİ ADEDİ BOX QUANTITY
15932	3 / 16 x 1"	25	500
15934	3 / 20 x 1"	25	350



## DAMLA SULAMA KURTAĞZI / DRIPLINE BARBED FITTINGS

KOD CODE	EBAT / SIZE d x G	AMBALAJ ADEDİ PACKING QUANTITY	KOLİ ADEDİ BOX QUANTITY
15942	4 / 16 x 1"	25	400
15944	4 / 20 x 1"	25	275



**KURTAĞZI ÇOKLU DAĞITIM NİPELİ**  
BARBED MULTICOUPLING NIPPLE

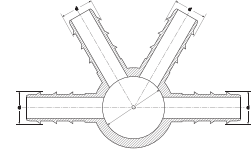

KOD CODE	EBAT / SIZE d x G	AMBALAJ ADEDİ PACKING QUANTITY	KOLİ ADEDİ BOX QUANTITY
15945	4 x / 16 x 1"	25	400
15947	4 x / 20 x 1"	25	250



**KURTAĞZI ÇOKLU DAĞITIM NİPELİ**  
BARBED MULTICOUPLING NIPPLE

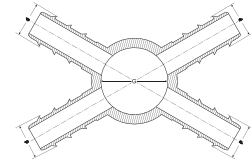

KOD CODE	EBAT / SIZE d x G	AMBALAJ ADEDİ PACKING QUANTITY	KOLİ ADEDİ BOX QUANTITY
15962	6 / 16 x 1"	25	300
15964	6 / 20 x 1"	25	175



**KURTAĞZI ÇOKLU DAĞITIM NİPELİ**  
BARBED MULTICOUPLING NIPPLE

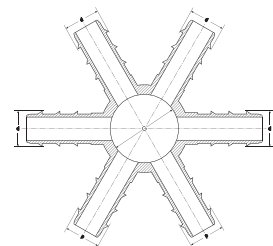

## DAMLA SULAMA KURTAĞZI / DRIPLINE BARBED FITTINGS

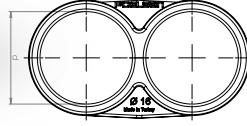

**DAMLAMA GÖZLÜK KÖR TAPA**  
FOLDING HOSE CONNECTOR END PLUG

KOD CODE	EBAT SIZE-d	AMBALAJ ADEDİ PACKING QUANTITY	KOLİ ADEDİ BOX QUANTITY
15723	16	100	4500
15743	20	100	3000

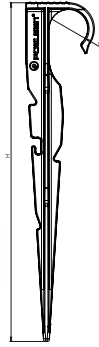

**DAMLAMA BORU SABİTLEME KAZIĞI-KISA**  
DRIPLINE PIPE STAKE-SHORT

KOD CODE	EBAT / SIZE d / H	AMBALAJ ADEDİ PACKING QUANTITY	KOLİ ADEDİ BOX QUANTITY
16051	16 / 150	100	1300
16052	20 / 150	100	1200

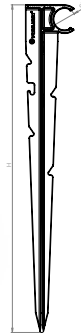

**DAMLAMA BORU SABİTLEME KAZIĞI-UZUN**  
DRIPLINE PIPE STAKE-LONG

KOD CODE	EBAT / SIZE d / H	AMBALAJ ADEDİ PACKING QUANTITY	KOLİ ADEDİ BOX QUANTITY
16053	16 / 250	50	600
16054	20 / 250	50	550

## DAMLA SULAMA KURTAĞZI / DRIPLINE BARBED FITTINGS

KOD CODE	EBAT / SIZE d x G	AMBALAJ ADEDİ PACKING QUANTITY	KOLİ ADEDİ BOX QUANTITY
16096	16	20	760
16098	20	20	660



**BORU DELME APARATI**  
DRILLER

KOD CODE	EBAT / SIZE d x G	AMBALAJ ADEDİ PACKING QUANTITY	KOLİ ADEDİ BOX QUANTITY
16092	16	20	320
16094	20	20	300



**BORU DELME EL APARATI**  
MANUEL DRILLER

KOD CODE	EBAT / SIZE d x G	AMBALAJ ADEDİ PACKING QUANTITY	KOLİ ADEDİ BOX QUANTITY
16097	16	20	660



**BORU DELME APARATI - D.Ç:18mm**  
DRILLER - DD:18mm

KOD CODE	EBAT / SIZE d x G	AMBALAJ ADEDİ PACKING QUANTITY	KOLİ ADEDİ BOX QUANTITY
15962	16	20	300



**BORU DELME EL APARATI - D.Ç:18mm**  
MANUEL DRILLER - DD:18mm

# DAMLA SULAMA KURTAĞZI

## DRIPLINE BARBED FITTINGS

### DİKKAT EDİLMESİ GEREKEN HUSUSLAR

- + Grommet Conta ile çıkış almak için kullanılacak Grommet Contalı ürün çeşidine göre delik çapı 16 mm veya 20 mm olacak şekilde boru delinmelidir.
- + Kurtağzı Grommet Conta ile çıkış almak için kullanılacak Kurtağzı Ek Parça çeşidine göre delik çapı 20 mm olacak şekilde boru delinmelidir.
- + Kurtağzı Ek Parçalar boruya takıldıktan sonra boru, Poelsan Boru Kelepçesi ile sıkıştırılmalıdır.

### POINTS TO TAKE INTO CONSIDERATION

- + For a proper offtake with the Grommet Gasket, the pipe should be punched 16 mm or 20 mm according to the Grommet Gasket to be used.
- + For a proper offtake with the Barbed Grommet Gasket, the pipe should be punched 20 mm according to the Barbed Fitting to be used.
- + The pipe should be clamped with Poelsan Pipe Clip after the Barbed Fittings are installed to the pipe.

## DAMLA SULAMA SOMUNLU DRIPLINE FITTINGS WITH NUT

### Özellikler

- + Darbelere karşı dayanıklı, yüksek kaliteli polipropilen hammaddeden üretilmiştir.
- + Ø16 mm ve Ø20 mm Yuvarlak Damla Sulama Borularında kullanılır.
- + UV ışınlarını geçirmediği için yosunlanmaya ve bakteri üremesine izin vermez.
- + İç yüzeyleri homojen ve gözeneksizdir.
- + Suyun kokusunu ve tadını değiştirebilecek zararlı bileşikler içermez.

### Specifications

- + It has been produced from high quality polypropylene raw material and it has resistance to impact.
- + Used with Ø16 mm and Ø20 mm Drip Irrigation Circular Pipe.
- + They prevent alga and bacteria forming due to UV proof (ultraviolet beam) structure.
- + It has a homogeneous and non-porous inner surface.
- + It does not contain any harmful compounds which can change the taste or the smell of the water.

### KULLANIM ALANLARI

- + Tarımsal Sulama
- + Peyzaj Sektörü
- + Seralar

### INSTALLATION AREAS

- + Agricultural Irrigation
- + Landscaping Systems
- + Greenhouses



TS EN ISO 9261

# DAMLAMA SULAMA SOMUNLU / DRIPLINE FITTINGS WITH NUT

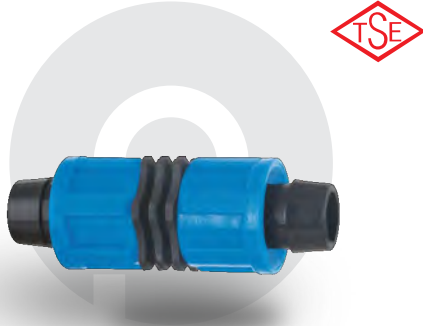

**DAMLAMA NİPEL**  
DRIPLINE NIPPLE

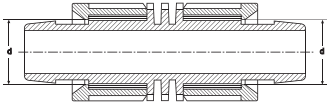

KOD CODE	EBAT / SIZE d x d	AMBALAJ ADEDİ PACKING QUANTITY	KOLİ ADEDİ BOX QUANTITY
16122	16 x 16	100	1400
16142	20 x 16	100	1100
16144	20 x 20	100	1000



**DAMLAMA - ERKEK NİPEL**  
DRIPLINE - MALE NIPPLE

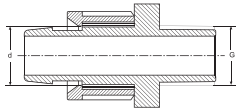

KOD CODE	EBAT / SIZE d x G	AMBALAJ ADEDİ PACKING QUANTITY	KOLİ ADEDİ BOX QUANTITY
16221	16 x 1/2"	100	1700
16222	16 x 3/4"	100	1500
16241	20 x 1/2"	100	1300
16242	20 x 3/4"	100	1200

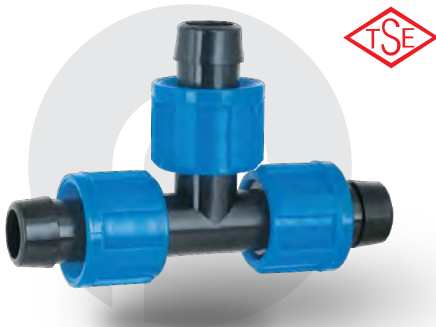

**DAMLAMA TE**  
DRIPLINE TEE

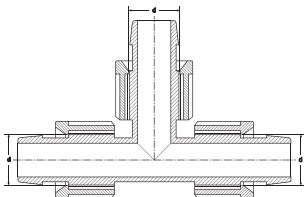

KOD CODE	EBAT / SIZE d x d x d	AMBALAJ ADEDİ PACKING QUANTITY	KOLİ ADEDİ BOX QUANTITY
16322	16 x 16 x 16	100	800
16342	20 x 16 x 20	100	500
16344	20 x 20 x 20	100	500



# DAMLAMA SULAMA SOMUNLU / DRIPLINE FITTINGS WITH NUT

KOD CODE	EBAT / SIZE d x G x d	AMBALAJ ADEDİ PACKING QUANTITY	KOLİ ADEDİ BOX QUANTITY
16421	16 x ½" x 16	100	900
16422	16 x ¾" x 16	100	800
16441	20 x ½" x 20	100	600
16442	20 x ¾" x 20	100	600
16443	20 x 1" x 20	100	500

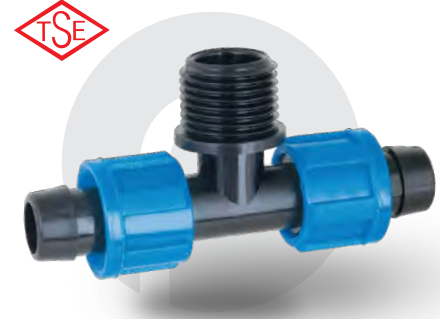

**DAMLAMA - ERKEK TE**  
DRIPLINE - MALE TEE

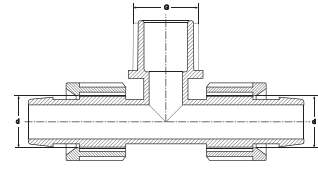

KOD CODE	EBAT / SIZE d x d	AMBALAJ ADEDİ PACKING QUANTITY	KOLİ ADEDİ BOX QUANTITY
16522	16 x 16	100	1400
16544	20 x 20	100	800



**DAMLAMA DİRSEK**  
DRIPLINE ELBOW

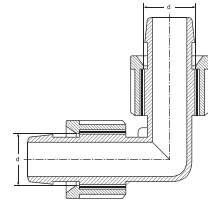

KOD CODE	EBAT / SIZE d x G	AMBALAJ ADEDİ PACKING QUANTITY	KOLİ ADEDİ BOX QUANTITY
16621	16 x ½"	100	1600
16622	16 x ¾"	100	1400
16641	20 x ½"	100	1100
16642	20 x ¾"	100	1000



**DAMLAMA - ERKEK DİRSEK**  
DRIPLINE - MALE ELBOW

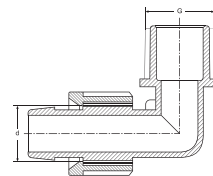

# DAMLAMA SULAMA SOMUNLU / DRIPLINE FITTINGS WITH NUT



**DAMLAMA KÖR TAPA**  
DRIPLINE END CAP

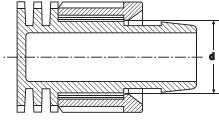

KOD CODE	EBAT / SIZE d	AMBALAJ ADEDİ PACKING QUANTITY	KOLİ ADEDİ BOX QUANTITY
16722	16	100	2400
16744	20	100	1600



**DAMLAMA - KURTAĞZI NİPEL**  
DRIPLINE - BARBED NIPPLE

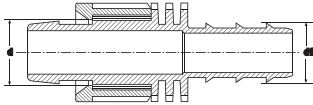

KOD CODE	EBAT / SIZE d x d <sub>1</sub>	AMBALAJ ADEDİ PACKING QUANTITY	KOLİ ADEDİ BOX QUANTITY
16766	16 x 16	100	1800
16788	20 x 20	100	1100



**DAMLAMA - GROMMET NİPEL**  
DRIPLINE - GROMMET NIPPLE

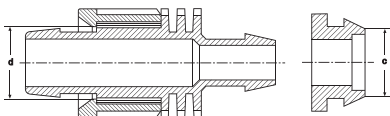

KOD CODE	EBAT / SIZE d x c	AMBALAJ ADEDİ PACKING QUANTITY	KOLİ ADEDİ BOX QUANTITY
16822	16 x 16	100	1600
16842	20 x 16	100	1200
16844	20 x 20	100	1100

# DAMLA SULAMA SOMUNLU / DRIPLINE FITTINGS WITH NUT

KOD CODE	EBAT / SIZE d x c	AMBALAJ ADEDİ PACKING QUANTITY	KOLİ ADEDİ BOX QUANTITY
16823	16 x 16	100	1400
16843	20 x 16	100	1100



**DAMLAMA - GROMMET NİPEL - D.Ç:18mm**  
DRIPLINE - GROMMET NIPPLE - DD:18mm

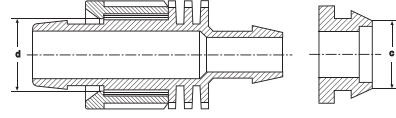

KOD CODE	EBAT / SIZE d	AMBALAJ ADEDİ PACKING QUANTITY	KOLİ ADEDİ BOX QUANTITY
16862	16	100	1300
16884	20	100	1000



**DAMLAMA - CONTASIZ ÇIKIŞ NİPELİ**  
DRIPLINE - OFFTAKE NIPPLE WITHOUT GASKET

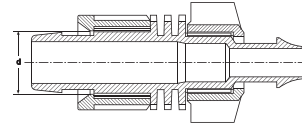

KOD CODE	EBAT SIZE-mm	AMBALAJ ADEDİ PACKING QUANTITY	KOLİ ADEDİ BOX QUANTITY
16888	8	100	2200



**CONTASIZ ÇIKIŞ KÖR TAPA**  
OFFTAKE WITHOUT GASKET END CAP

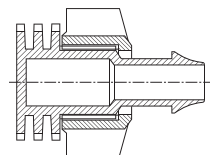

D.Ç:Delme Çapı / DD:Drilling Diameter

# DAMLA SULAMA SOMUNLU / DRIPLINE FITTINGS WITH NUT



**CONTASIZ ÇIKIŞ NİPELİ**  
OFFTAKE NIPPLE WITHOUT GASKET

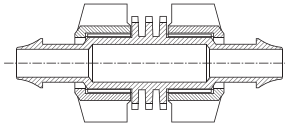

KOD CODE	EBAT SIZE-mm	AMBALAJ ADEDİ PACKING QUANTITY	KOLİ ADEDİ BOX QUANTITY
16899	12	100	1200



**DAMLAMA ÇOKLU DAĞITIM NİPELİ**  
DRIPLINE MULTICOUPLING NIPPLE

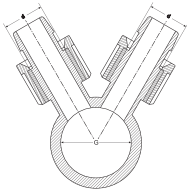

KOD CODE	EBAT / SIZE d x G	AMBALAJ ADEDİ PACKING QUANTITY	KOLİ ADEDİ BOX QUANTITY
16922	2 / 16 x 1"	25	500
16924	2 / 20 x 1"	25	400



**DAMLAMA ÇOKLU DAĞITIM NİPELİ**  
DRIPLINE MULTICOUPLING NIPPLE

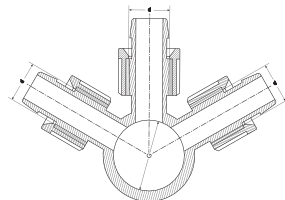

KOD CODE	EBAT / SIZE d x G	AMBALAJ ADEDİ PACKING QUANTITY	KOLİ ADEDİ BOX QUANTITY
16932	3 / 16 x 1"	25	400
16934	3 / 20 x 1"	25	300

# DAMLAMA SÜZÜLMÜSÜ / DRIPLINE FITTINGS WITH NUT

KOD CODE	EBAT / SIZE d x G	AMBALAJ ADEDİ PACKING QUANTITY	KOLİ ADEDİ BOX QUANTITY
16942	4 / 16 x 1"	25	300
16944	4 / 20 x 1"	25	225



**DAMLAMA ÇOKLU DAĞITIM NİPELİ**  
DRIPLINE MULTICOUPLING NIPPLE

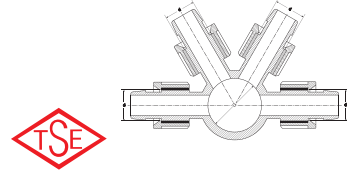

KOD CODE	EBAT / SIZE d x G	AMBALAJ ADEDİ PACKING QUANTITY	KOLİ ADEDİ BOX QUANTITY
16945	4 x / 16 x 1"	25	300
16947	4 x / 20 x 1"	25	200



**DAMLAMA ÇOKLU DAĞITIM NİPELİ**  
DRIPLINE MULTICOUPLING NIPPLE

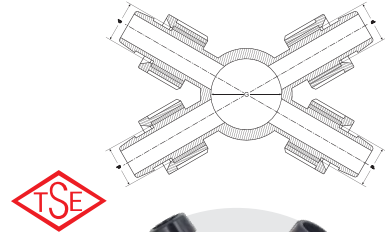

KOD CODE	EBAT / SIZE d x G	AMBALAJ ADEDİ PACKING QUANTITY	KOLİ ADEDİ BOX QUANTITY
16962	6 / 16 x 1"	25	225
16964	6 / 20 x 1"	25	150



**DAMLAMA ÇOKLU DAĞITIM NİPELİ**  
DRIPLINE MULTICOUPLING NIPPLE

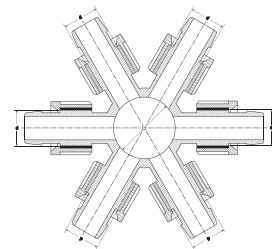

# DAMLA SULAMA SOMUNLU

## DRIPLINE FITTINGS WITH NUT

### DİKKAT EDİLMESİ GEREKEN HUSUSLAR

- + Grommet Conta ile çıkış almak için kullanılacak grommet contalı ürün çeşidine göre delik çapı 16 mm veya 20 mm olacak şekilde boru delinmelidir.
- + Contasız Çıkış, Layflat ve Alçak Yoğunluklu Polietilen (AYPE) Borulardan (Düz Damla Sulama Borusu), Ø16 mm ve Ø20 mm Damla Sulama Borularına çıkış almak için kullanılır. Contasız Çıkış Ucu ile çıkış almak için boru, delik çapı 8 mm olacak şekilde delinmelidir.
- + Contasız Çıkış Nipelü ürünü, Layflat Borulardan, Ø12 mm Spagetti Borulara çıkış almak için kullanılır. Contasız Çıkış Ucu ile çıkış almak için boru, delik çapı 8 mm olacak şekilde delinmelidir.

### POINTS TO TAKE INTO CONSIDERATION

- + For a proper offtake with the Grommet Gasket, the pipe should be punched 16 mm or 20 mm according to the grommet gasket to be used.
- + The items with offtake without gasket are used for joining the Layflat and Low Density Polyethylene (LDPE) Pipes (Flat Drip Irrigation Pipe) With Drip Irrigation Pipe (Ø16 mm & Ø20 mm). For a proper offtake, the pipe should be punched 8 mm.
- + The Offtake Nipple item is used for joining the Layflat Pipes with Ø12 mm Microtube Pipes. For a proper offtake, the pipe should be punched 8 mm.



## YASSI DAMLA SULAMA SOMUNLU DRIP TAPE FITTINGS WITH NUT

### Özellikler

- + Darbelere karşı dayanıklı, yüksek kaliteli polipropilen hammaddeden üretilmiştir.
- + Ø17 mm ve Ø22 mm Yassı Damla Sulama Borularında kullanılır.
- + UV ışınlarını geçirmediği için yosunlanmaya ve bakteri üremesine izin vermez.
- + İç yüzeyleri homojen ve gözeneksizdir.
- + Suyun kokusunu ve tadını değiştirebilecek zararlı bileşikler içermez.

### Specifications

- + It has been produced from high quality polypropylene raw material and **it has resistance to impact.**
- + Used with Ø17 mm and Ø22 mm Tape Driplines.
- + **They prevent alga and bacteria forming** due to UV proof (ultraviolet beam) structure.
- + **It has a homogeneous and non-porous inner surface.**
- + It does not contain any **harmful compounds** which can change the taste or the smell of the water.



TS EN ISO 9261

### KULLANIM ALANLARI

- + Tarımsal Sulama
- + Peyzaj Sektörü
- + Seralar

### INSTALLATION AREAS

- + Agricultural Irrigation
- + Landscaping Systems
- + Greenhouses

# YASSI DAMLA SULAMA SOMUNLU / DRIP TAPE FITTINGS WITH NUT

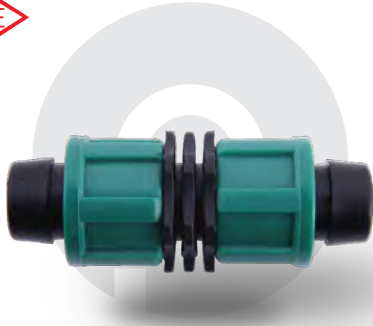

**YASSI NİPEL**  
TAPE NIPPLE

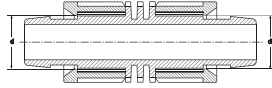

KOD CODE	EBAT / SIZE d x d	AMBALAJ ADEDİ PACKING QUANTITY	KOLİ ADEDİ BOX QUANTITY
17122	17 x 17	100	1400
17144	22 x 22	100	600
17155	25 x 25	100	500



**YASSI - ERKEK NİPEL**  
TAPE - MALE NIPPLE

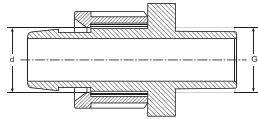

KOD CODE	EBAT / SIZE d x G	AMBALAJ ADEDİ PACKING QUANTITY	KOLİ ADEDİ BOX QUANTITY
17221	17 x 1/2"	100	1600
17222	17 x 3/4"	100	1400
17242	22 x 3/4"	100	1000
17252	25 x 3/4"	100	700

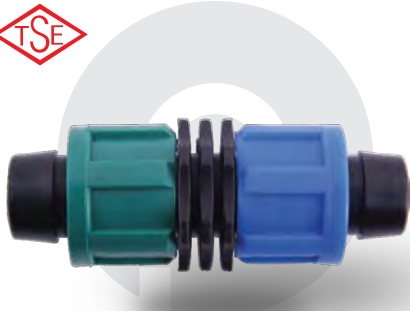

**YASSI - DAMLAMA NİPEL**  
TAPE - DRIPLINE NIPPLE

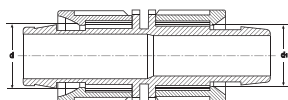

KOD CODE	EBAT / SIZE d x d <sub>1</sub>	AMBALAJ ADEDİ PACKING QUANTITY	KOLİ ADEDİ BOX QUANTITY
17322	17 x 16	100	1400
17344	22 x 20	100	700
17354	25 x 20	100	600

## YASSI DAMLA SULAMA SOMUNLU / DRIP TAPE FITTINGS WITH NUT

KOD CODE	EBAT / SIZE d x d <sub>1</sub>	AMBALAJ ADEDİ PACKING QUANTITY	KOLİ ADEDİ BOX QUANTITY
17422	17 x 16	100	1600
17444	22 x 20	100	700
17454	25 x 20	100	600



**YASSI - KURTAĞZI NİPEL**  
TAPE - BARBED NIPPLE

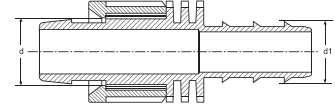

KOD CODE	EBAT / SIZE d x c	AMBALAJ ADEDİ PACKING QUANTITY	KOLİ ADEDİ BOX QUANTITY
17522	17 x 16	100	1600
17544	22 x 20	100	800



**YASSI - GROMMET NİPEL**  
TAPE - GROMMET NIPPLE

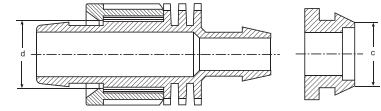

KOD CODE	EBAT / SIZE d x c	AMBALAJ ADEDİ PACKING QUANTITY	KOLİ ADEDİ BOX QUANTITY
17523	17 x 16	100	1400



**YASSI - GROMMET NİPEL - D.Ç:18mm**  
TAPE - GROMMET NIPPLE - DD:18mm

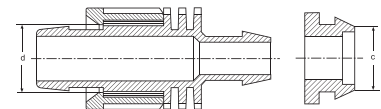

D.Ç:Delme Çapı / DD:Drilling Diameter

## YASSI DAMLA SULAMA SOMUNLU / DRIP TAPE FITTINGS WITH NUT



**YASSI - CONTASIZ ÇIKIŞ NİPELİ**  
TAPE - OFFTAKE NIPPLE WITHOUT GASKET

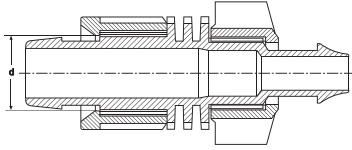

KOD CODE	EBAT / SIZE d	AMBALAJ ADEDİ PACKING QUANTITY	KOLİ ADEDİ BOX QUANTITY
17562	17	100	1200
17584	22	100	800



**YASSI TE**  
TAPE TEE

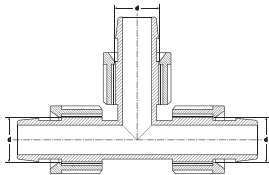

KOD CODE	EBAT / SIZE d x d x d	AMBALAJ ADEDİ PACKING QUANTITY	KOLİ ADEDİ BOX QUANTITY
17622	17 x 17 x 17	100	800
17655	25 x 25 x 25	50	300



**YASSI - ERKEK TE**  
TAPE - MALE TEE

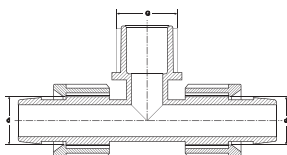

KOD CODE	EBAT / SIZE d x G x d	AMBALAJ ADEDİ PACKING QUANTITY	KOLİ ADEDİ BOX QUANTITY
17721	17 x 1/2" x 17	100	800
17722	17 x 3/4" x 17	100	800
17723	17 x 1" x 17	100	600
17751	25 x 1/2" x 25	50	400
17752	25 x 3/4" x 25	50	300
17753	25 x 1" x 25	50	300

# YASSI DAMLA SULAMA SOMUNLU / DRIP TAPE FITTINGS WITH NUT

KOD CODE	EBAT / SIZE d x d	AMBALAJ ADEDİ PACKING QUANTITY	KOLİ ADEDİ BOX QUANTITY
17822	17 x 17	100	1400
17855	25 x 25	100	400



**YASSI DİRSEK**  
TAPE ELBOW

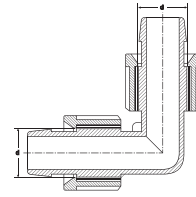

KOD CODE	EBAT / SIZE d x G	AMBALAJ ADEDİ PACKING QUANTITY	KOLİ ADEDİ BOX QUANTITY
17921	17 x 1/2"	100	1600
17922	17 x 3/4"	100	1200
17951	25 x 1/2"	100	600
17952	25 x 3/4"	100	600
17953	25 x 1"	100	500



**YASSI - ERKEK DİRSEK**  
TAPE - MALE ELBOW

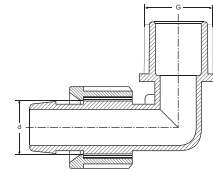

KOD CODE	EBAT / SIZE d	AMBALAJ ADEDİ PACKING QUANTITY	KOLİ ADEDİ BOX QUANTITY
18022	17	100	2400
18044	22	100	1200
18055	25	100	1000



**YASSI KÖR TAPA**  
TAPE END CAP

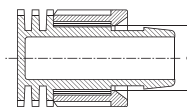

# YASSI DAMLA SULAMA SOMUNLU / DRIP TAPE FITTINGS WITH NUT



**YASSI DAMLAMA ÇOKLU DAĞITIM NİPELİ**  
TAPE MULTICOUPLING NIPPLE

KOD CODE	EBAT / SIZE d x G	AMBALAJ ADEDİ PACKING QUANTITY	KOLİ ADEDİ BOX QUANTITY
18122	2 / 17 x 1"	25	550
18124	2 / 22 x 1"	25	350
18125	2 / 25 x 1"	25	300

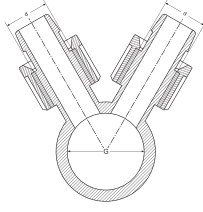

**YASSI DAMLAMA ÇOKLU DAĞITIM NİPELİ**  
TAPE MULTICOUPLING NIPPLE

KOD CODE	EBAT / SIZE d x G	AMBALAJ ADEDİ PACKING QUANTITY	KOLİ ADEDİ BOX QUANTITY
18127	2 / 22 x 1"	25	300

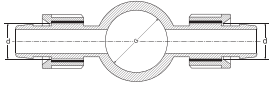

**YASSI DAMLAMA ÇOKLU DAĞITIM NİPELİ**  
TAPE MULTICOUPLING NIPPLE

KOD CODE	EBAT / SIZE d x G	AMBALAJ ADEDİ PACKING QUANTITY	KOLİ ADEDİ BOX QUANTITY
18132	3 / 17 x 1"	25	400
18134	3 / 22 x 1"	25	250
18135	3 / 25 x 1"	25	200

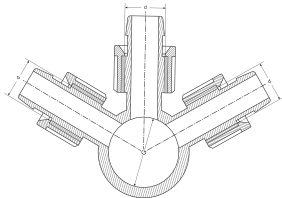



## YASSI DAMLA SULAMA SOMUNLU / DRIP TAPE FITTINGS WITH NUT

KOD CODE	EBAT / SIZE d x G	AMBALAJ ADEDİ PACKING QUANTITY	KOLİ ADEDİ BOX QUANTITY
18142	4 / 17 x 1"	25	300
18144	4 / 22 x 1"	25	200
181444	4 / 25 x 1"	25	150



YASSI DAMLAMA ÇOKLU DAĞITIM NİPELİ  
TAPE MULTICOUPLING NIPPLE

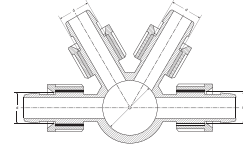

KOD CODE	EBAT / SIZE d x G	AMBALAJ ADEDİ PACKING QUANTITY	KOLİ ADEDİ BOX QUANTITY
18145	4 x / 17 x 1"	25	350
18147	4 x / 22 x 1"	25	175
18148	4 x / 25 x 1"	25	150



YASSI DAMLAMA ÇOKLU DAĞITIM NİPELİ  
TAPE MULTICOUPLING NIPPLE

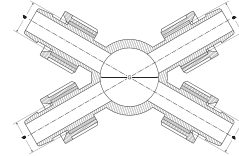

KOD CODE	EBAT / SIZE d x G	AMBALAJ ADEDİ PACKING QUANTITY	KOLİ ADEDİ BOX QUANTITY
18162	6 / 17 x 1"	25	250
18164	6 / 22 x 1"	25	100
18165	6 / 25 x 1"	25	100



YASSI DAMLAMA ÇOKLU DAĞITIM NİPELİ  
TAPE MULTICOUPLING NIPPLE

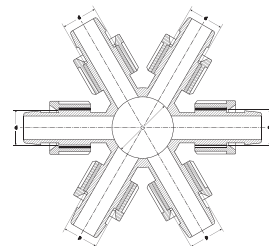

# YASSI DAMLA SULAMA SOMUNLU

## DRIP TAPE FITTINGS WITH NUT

### DİKKAT EDİLMESİ GEREKEN HUSUSLAR

- + Grommet Conta ile çıkış almak için kullanılacak grommet contalı ürün çeşidine göre delik çapı 16 mm veya 20 mm olacak şekilde boru delinmelidir.
- + Contasız Çıkış, Layflat ve Alçak Yoğunluklu Polietilen (AYPE) Borulardan (Düz Damla Sulama Borusu), Ø17 mm ve Ø22 mm Yassı Damla Sulama Borularına çıkış almak için kullanılır. Contasız Çıkış Ucu ile çıkış almak için boru, delik çapı 8 mm olacak şekilde delinmelidir.

### POINTS TO TAKE INTO CONSIDERATION

- + For a proper offtake with the Grommet Gasket, the pipe should be punched 16 mm or 20 mm according to the Grommet Gasket to be used.
- + The items with offtake without gasket are used for joining the Layflat and Low Density Polyethylene (LDPE) Pipes (Flat Drip Irrigation Pipe) with Flat Drip Irrigation Pipe Ø17 mm & Ø22 mm. For a proper offtake, the pipe should be punched 8 mm.

## YASSI DAMLA SULAMA YÜZÜKLÜ DRIP TAPE FITTINGS WITH RING

### Özellikler

- + Darbelere karşı dayanıklı, yüksek kaliteli polipropilen hammaddeden üretilmiştir.
- + Ø17 mm dikişsiz Yassı Damla Sulama Borularında kullanılır.
- + UV ışınlarını geçirmediği için yosunlanmaya ve bakteri üremesine izin vermez.
- + İç yüzeyleri homojen ve gözeneksizdir.
- + Suyun kokusunu ve tadını değiştirebilecek zararlı bileşikler içermez.

### Specifications

- + It has been produced from high quality polypropylene raw material and it has resistance to impact.
- + Used with seamless Ø17 mm Tape Driplines.
- + They prevent alga and bacteria forming due to UV proof (ultraviolet beam) structure.
- + It has a homogeneous and non-porous inner surface.
- + It does not contain any harmful compounds which can change the taste or the smell of the water.

### KULLANIM ALANLARI

- + Tarımsal Sulama
- + Peyzaj Sektörü
- + Seralar

### INSTALLATION AREAS

- + Agricultural Irrigation
- + Landscaping Systems
- + Greenhouses



TS EN ISO 9261



## YASSI DAMLA SULAMA YÜZÜKLÜ / DRIP TAPE FITTINGS WITH RING



**YÜZÜKLÜ YASSI NİPEL**  
DRIP TAPE (WITH RING) NIPPLE

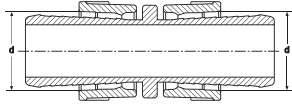

KOD CODE	EBAT / SIZE d x d	AMBALAJ ADEDİ PACKING QUANTITY	KOLİ ADEDİ BOX QUANTITY
18522	17 x 17	100	2500



**YÜZÜKLÜ YASSI - ERKEK NİPEL**  
DRIP TAPE (WITH RING) - MALE NIPPLE

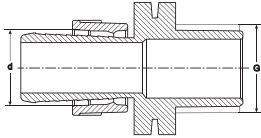

KOD CODE	EBAT / SIZE d x G	AMBALAJ ADEDİ PACKING QUANTITY	KOLİ ADEDİ BOX QUANTITY
18621	17 x 1/2"	100	1600
18622	17 x 3/4"	100	1600



**YÜZÜKLÜ YASSI - KURTAĞZI NİPEL**  
DRIP TAPE (WITH RING) - BARBED NIPPLE

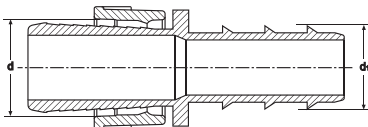

KOD CODE	EBAT / SIZE d x d1	AMBALAJ ADEDİ PACKING QUANTITY	KOLİ ADEDİ BOX QUANTITY
18822	17 x 16	100	2800

## YASSI DAMLA SULAMA YÜZÜKLÜ / DRIP TAPE FITTINGS WITH RING

KOD CODE	EBAT / SIZE d x c	AMBALAJ ADEDİ PACKING QUANTITY	KOLİ ADEDİ BOX QUANTITY
18922	17 x 16	100	2600



**YÜZÜKLÜ YASSI - GROMMET NİPEL**  
DRIP TAPE (WITH RING) - GROMMET NIPPLE

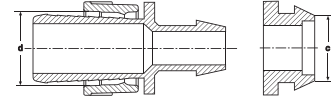

KOD CODE	EBAT / SIZE d x c	AMBALAJ ADEDİ PACKING QUANTITY	KOLİ ADEDİ BOX QUANTITY
18923	17 x 16	100	2000



**YÜZÜKLÜ YASSI - GROMMET NİPEL - D.Ç:18mm**  
DRIP TAPE (WITH RING) - GROMMET NIPPLE - DD:18mm

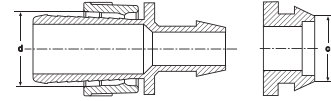

KOD CODE	EBAT / SIZE d x d x d	AMBALAJ ADEDİ PACKING QUANTITY	KOLİ ADEDİ BOX QUANTITY
19022	17 x 17 x 17	100	1300



**YÜZÜKLÜ YASSI TE**  
DRIP TAPE (WITH RING) TEE

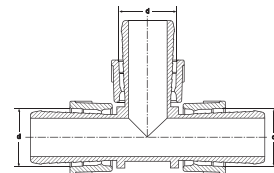

D.Ç:Delme Çapı / DD:Drilling Diameter

## YASSI DAMLA SULAMA YÜZÜKLÜ / DRIP TAPE FITTINGS WITH RING



**YÜZÜKLÜ YASSI - ERKEK TE**  
DRIP TAPE ( WITH RING) - MALE TEE

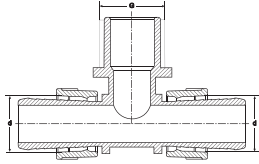

KOD CODE	EBAT / SIZE d x G x d	AMBALAJ ADEDİ PACKING QUANTITY	KOLİ ADEDİ BOX QUANTITY
19121	17 x 1/2" x 17	100	1200
19122	17 x 3/4" x 17	100	1000
19123	17 x 1" x 17	100	900



**YÜZÜKLÜ YASSI DİRSEK**  
DRIP TAPE (WITH RING) ELBOW

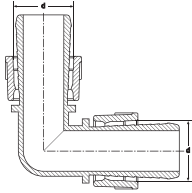

KOD CODE	EBAT / SIZE d x d	AMBALAJ ADEDİ PACKING QUANTITY	KOLİ ADEDİ BOX QUANTITY
19222	17 x 17	100	1800



**YÜZÜKLÜ YASSI - ERKEK DİRSEK**  
DRIP TAPE (WITH RING) - MALE ELBOW

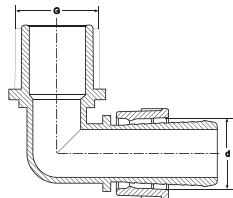

KOD CODE	EBAT / SIZE d x G	AMBALAJ ADEDİ PACKING QUANTITY	KOLİ ADEDİ BOX QUANTITY
19321	17 x 1/2"	100	1800
19322	17 x 3/4"	100	1400



KOD CODE	EBAT / SIZE d	AMBALAJ ADEDİ PACKING QUANTITY	KOLİ ADEDİ BOX QUANTITY
19422	17	100	4000



**YÜZÜKLÜ YASSI KÖR TAPA**  
TAPE (WITH RING) END CAP

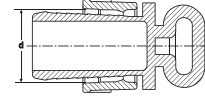

KOD CODE	EBAT / SIZE d x G	AMBALAJ ADEDİ PACKING QUANTITY	KOLİ ADEDİ BOX QUANTITY
19522	2 / 17 x 1"	25	600



**YÜZÜKLÜ YASSI ÇOKLU DAĞITIM NİPELİ**  
TAPE (WITH RING) MULTICOUPLING NIPPLE

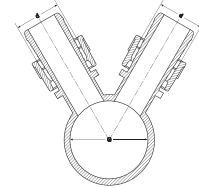

KOD CODE	EBAT / SIZE d x G	AMBALAJ ADEDİ PACKING QUANTITY	KOLİ ADEDİ BOX QUANTITY
19532	3 / 17 x 1"	25	500



**YÜZÜKLÜ YASSI ÇOKLU DAĞITIM NİPELİ**  
TAPE (WITH RING) MULTICOUPLING NIPPLE

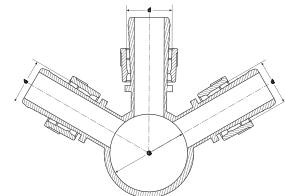

## YASSI DAMLA SULAMA YÜZÜKLÜ / DRIP TAPE FITTINGS WITH RING



KOD CODE	EBAT / SIZE d x G	AMBALAJ ADEDİ PACKING QUANTITY	KOLİ ADEDİ BOX QUANTITY
19542	4 / 17 x 1"	25	400

**YÜZÜKLÜ YASSI ÇOKLU DAĞITIM NİPELİ**  
TAPE (WITH RING) MULTICOUPLING NIPPLE

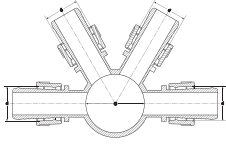

KOD CODE	EBAT / SIZE d x G	AMBALAJ ADEDİ PACKING QUANTITY	KOLİ ADEDİ BOX QUANTITY
19545	4 x / 17 x 1"	25	375

**YÜZÜKLÜ YASSI ÇOKLU DAĞITIM NİPELİ**  
TAPE (WITH RING) MULTICOUPLING NIPPLE

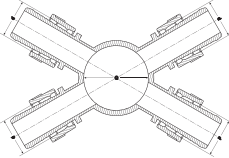

KOD CODE	EBAT / SIZE d x G	AMBALAJ ADEDİ PACKING QUANTITY	KOLİ ADEDİ BOX QUANTITY
19562	6 / 17 x 1"	25	275

**YÜZÜKLÜ YASSI ÇOKLU DAĞITIM NİPELİ**  
TAPE (WITH RING) MULTICOUPLING NIPPLE

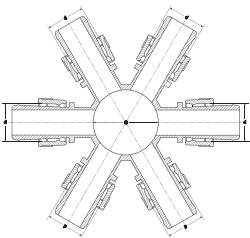

# YASSI DAMLA SULAMA YÜZÜKLÜ

## DRIP TAPE FITTINGS WITH RING

### DİKKAT EDİLMESİ GEREKEN HUSUSLAR

- + Grommet Conta ile çıkış almak için kullanılacak grommet contalı ürün çeşidine göre delik çapı 16 mm olacak şekilde boru delinmelidir.

### POINTS TO TAKE INTO CONSIDERATION

- + For a proper offtake with the Grommet Gasket, the pipe should be punched 16 mm according to the Grommet Gasket to be used.

# MİNİSPRİNKLER VE EK PARÇALARI

## MINISPRINKLERS & FITTINGS

### Özellikler

- + Mikrofittingler ile birlikte Ø7 mm Spagetti Borularda ve Ø16 mm, Ø20 mm, Ø25 mm ve Ø32 mm Alçak Yoğunluklu Polietilen (AYPE) Borularda (Düz Damla Sulama Borusu) kullanılır.
- + Minisprinklerin rotorları toz, böcek vb. girmesini önleyecek şekilde tasarlanmıştır.
- + Alan sulamalarında kullanılabilecek, maksimum verim sağlayan en ideal üründür.
- + Bitkinin büyümesi için gerekli suyun doğrudan bitki köklerine ulaşmasını sağlar.
- + Soğuk hava şartlarına karşı etkin koruma sağlar.

### Specifications

- + Minisprinklers are used in Ø16 mm, Ø20 mm, Ø25 mm and Ø32 mm Low Density Polyethylene Pipes (LDPE) (Flat Drip Irrigation Pipe) and Ø7 mm Spaghetti Tube together with Microfittings.
- + Rotors of Minisprinklers are designed to prevent the entry of dust and insects, etc.
- + It is the most ideal product to be used in irrigation, and provides maximum efficiency.
- + Rotating Minisprinklers provide necessary irrigation directly to the roots of a plant.
- + It provides effective protection against cold weather conditions.

**GARANTİ VERİLEN BASINÇ DEĞERİ : PN 2**  
**GUARANTEED PRESSURE VALUE : PN 2**

### KULLANIM ALANLARI

- + Peyzaj Sektörü
- + Çiçek ve Sebze Bahçeleri
- + Fidanlıklar
- + Meyve Ağaçları
- + Seralar
- + Bahçe Sulamaları

### INSTALLATION AREAS

- + Landscaping Systems
- + Flower and Vegetable Gardens
- + Plantations
- + Fruit Trees
- + Greenhouses
- + Garden Irrigations



# MİNİSPRİNKLER VE EK PARÇALARI / MINISPRINKLERS & FITTINGS

KOD CODE	NOZUL RENGİ NOZZLE COLOR	BOŞALTIM DEĞERİ PRECIPITATION (Lt/h)	SULAMA ÇAPI IRRIGATION DIAMETER (m)		AMBALAJ ADEDİ PACKING QUANTITY	KOLİ ADEDİ BOX QUANTITY
			Tırnaklı With The Deflector	Tırnaksız Without The Deflector		
<b>22080</b>	<b>AÇIK YEŞİL</b>	<b>80</b>	<b>6.0</b>		<b>25</b>	<b>2000</b>
22100	AÇIK MAVİ	100	6.0		25	2000
<b>22120</b>	<b>KIRMIZI</b>	<b>120</b>	<b>6.5</b>		<b>25</b>	<b>2000</b>
22140	PEMBE	140	7.0		25	2000
<b>22160</b>	<b>KAHVERENGİ</b>	<b>160</b>	<b>7.0</b>		<b>25</b>	<b>2000</b>
22180	TURUNCU	180	7.5		25	2000
<b>22200</b>	<b>SARI</b>	<b>200</b>	<b>7.5</b>		<b>25</b>	<b>2000</b>
22265	BEYAZ	265	7.5		25	2000
<b>22320</b>	<b>YEŞİL</b>	<b>320</b>	<b>8.0</b>		<b>25</b>	<b>2000</b>
22360	MOR	360	8.0		25	2000
<b>22400</b>	<b>MAVİ</b>	<b>400</b>	<b>8.0</b>		<b>25</b>	<b>2000</b>



**MİNİSPRİNKLER  
UZUN MESAFE**  
MINISPRINKLERS LONG DISTANCE

KOD CODE	NOZUL RENGİ NOZZLE COLOR	BOŞALTIM DEĞERİ PRECIPITATION (Lt/h)	SULAMA ÇAPI IRRIGATION DIAMETER (m)		AMBALAJ ADEDİ PACKING QUANTITY	KOLİ ADEDİ BOX QUANTITY
			Tırnaklı With The Deflector	Tırnaksız Without The Deflector		
<b>23075</b>	<b>SİYAH</b>	<b>75</b>	<b>5.5</b>	<b>1.0</b>	<b>25</b>	<b>2000</b>
23080	AÇIK YEŞİL	80	6.0	1.0	25	2000
<b>23100</b>	<b>AÇIK MAVİ</b>	<b>100</b>	<b>6.0</b>	<b>1.0</b>	<b>25</b>	<b>2000</b>
23120	KIRMIZI	120	7.0	1.0	25	2000
<b>23140</b>	<b>PEMBE</b>	<b>140</b>	<b>7.0</b>	<b>1.0</b>	<b>25</b>	<b>2000</b>
23160	KAHVERENGİ	160	7.0	1.0	25	2000
<b>23180</b>	<b>TURUNCU</b>	<b>180</b>	<b>8.0</b>	<b>1.0</b>	<b>25</b>	<b>2000</b>
23200	SARI	200	8.0	1.0	25	2000



**MİNİSPRİNKLER  
TIRNAKLI UZUN MESAFE**  
MINISPRINKLERS  
LONG DISTANCE WITH DEFLECTOR

KOD CODE	NOZUL RENGİ NOZZLE COLOR	BOŞALTIM DEĞERİ PRECIPITATION (Lt/h)	SULAMA ÇAPI IRRIGATION DIAMETER (m)		AMBALAJ ADEDİ PACKING QUANTITY	KOLİ ADEDİ BOX QUANTITY
			Tırnaklı With The Deflector	Tırnaksız Without The Deflector		
<b>24060</b>	<b>GİRİ</b>	<b>60</b>	<b>3.5</b>	<b>1.0</b>	<b>25</b>	<b>2000</b>
24075	SİYAH	75	3.5	1.0	25	2000
<b>24080</b>	<b>AÇIK YEŞİL</b>	<b>80</b>	<b>3.5</b>	<b>1.0</b>	<b>25</b>	<b>2000</b>
24100	AÇIK MAVİ	100	4.0	1.0	25	2000
<b>24120</b>	<b>KIRMIZI</b>	<b>120</b>	<b>4.0</b>	<b>1.0</b>	<b>25</b>	<b>2000</b>
24140	PEMBE	140	4.0	1.0	25	2000
<b>24160</b>	<b>KAHVERENGİ</b>	<b>160</b>	<b>4.0</b>	<b>1.0</b>	<b>25</b>	<b>2000</b>
24400	MAVİ	400	4.0	1.0	25	2000



**MİNİSPRİNKLER  
TIRNAKLI KISA MESAFE**  
MINISPRINKLERS  
SHORT DISTANCE WITH DEFLECTOR

**Minisprinklerin Sulama Çapı değerleri, Poelsan Minisprink Montajlı Takımı kullanılarak 20 cm yükseklikte ve 2 bar basınçta ölçülen değerlerdir.**

Irrigation diameter values of Minisprinklers, by using Poelsan Minisprinkler Set is values measured PN 2 pressure and 20 cm height.

# MİNİSPRİNKLER VE EK PARÇALARI / MINISPRINKLERS & FITTINGS



**MİNİSPRİNKLER  
MONTAJLI TAKIM UZUN MESAFE**  
MINISPRINKLER SET LONG DISTANCE

KOD CODE	NOZUL RENGİ NOZZLE COLOR	BOŞALTIM DEĞERİ PRECIPITATION (Lt/h)	SULAMA ÇAPI IRRIGATION DIAMETER (m)		AMBALAJ ADEDİ PACKING QUANTITY	KOLİ ADEDİ BOX QUANTITY
<b>25080</b>	<b>AÇIK YEŞİL</b>	<b>80</b>	<b>6.0</b>		<b>25</b>	<b>175</b>
25100	AÇIK MAVİ	100	6.0		25	175
<b>25120</b>	<b>KIRMIZI</b>	<b>120</b>	<b>6.5</b>		<b>25</b>	<b>175</b>
25140	PEMBE	140	7.0		25	175
<b>25160</b>	<b>KAHVERENGİ</b>	<b>160</b>	<b>7.0</b>		<b>25</b>	<b>175</b>
25180	TURUNCU	180	7.5		25	175
<b>25200</b>	<b>SARI</b>	<b>200</b>	<b>7.5</b>		<b>25</b>	<b>175</b>
25265	BEYAZ	265	7.5		25	175
<b>25320</b>	<b>YEŞİL</b>	<b>320</b>	<b>8.0</b>		<b>25</b>	<b>175</b>
25360	MOR	360	8.0		25	175
<b>25400</b>	<b>MAVİ</b>	<b>400</b>	<b>8.0</b>		<b>25</b>	<b>175</b>



**MİNİSPRİNKLER MONTAJLI TAKIM  
TIRNAKLI UZUN MESAFE**  
MINISPRINKLER SET  
LONG DISTANCE WITH DEFLECTOR

KOD CODE	NOZUL RENGİ NOZZLE COLOR	BOŞALTIM DEĞERİ PRECIPITATION (Lt/h)	SULAMA ÇAPI IRRIGATION DIAMETER (m)		AMBALAJ ADEDİ PACKING QUANTITY	KOLİ ADEDİ BOX QUANTITY
			Tirnaklı Without The Deflector	Tirnaklı With The Deflector		
<b>26075</b>	<b>SİYAH</b>	<b>75</b>	<b>5.5</b>	<b>1.0</b>	<b>25</b>	<b>175</b>
26080	AÇIK YEŞİL	80	6.0	1.0	25	175
<b>26100</b>	<b>AÇIK MAVİ</b>	<b>100</b>	<b>6.0</b>	<b>1.0</b>	<b>25</b>	<b>175</b>
26120	KIRMIZI	120	7.0	1.0	25	175
<b>26140</b>	<b>PEMBE</b>	<b>140</b>	<b>7.0</b>	<b>1.0</b>	<b>25</b>	<b>175</b>
26160	KAHVERENGİ	160	7.0	1.0	25	175
<b>26180</b>	<b>TURUNCU</b>	<b>180</b>	<b>8.0</b>	<b>1.0</b>	<b>25</b>	<b>175</b>
26200	SARI	200	8.0	1.0	25	175



**MİNİSPRİNKLER MONTAJLI TAKIM  
TIRNAKLI KISA MESAFE**  
MINISPRINKLER SET  
SHORT DISTANCE WITH DEFLECTOR

KOD CODE	NOZUL RENGİ NOZZLE COLOR	BOŞALTIM DEĞERİ PRECIPITATION (Lt/h)	SULAMA ÇAPI IRRIGATION DIAMETER (m)		AMBALAJ ADEDİ PACKING QUANTITY	KOLİ ADEDİ BOX QUANTITY
			Tirnaklı Without The Deflector	Tirnaklı With The Deflector		
<b>27060</b>	<b>GİRİ</b>	<b>60</b>	<b>3.5</b>	<b>1.0</b>	<b>25</b>	<b>175</b>
27075	SİYAH	75	3.5	1.0	25	175
<b>27080</b>	<b>AÇIK YEŞİL</b>	<b>80</b>	<b>3.5</b>	<b>1.0</b>	<b>25</b>	<b>175</b>
27100	AÇIK MAVİ	100	4.0	1.0	25	175
<b>27120</b>	<b>KIRMIZI</b>	<b>120</b>	<b>4.0</b>	<b>1.0</b>	<b>25</b>	<b>175</b>
27140	PEMBE	140	4.0	1.0	25	175
<b>27160</b>	<b>KAHVERENGİ</b>	<b>160</b>	<b>4.0</b>	<b>1.0</b>	<b>25</b>	<b>175</b>
27400	MAVİ	400	4.0	1.0	25	175

**Minisprink, Spagetti Boru (90 cm), Kurtağzı Erkek Nipel (1 adet)  
Kurtağzı Dişi Nipel (2 adet), Kazık (1adet)**

Minisprinkler, Spaghetti Tube (90 cm), Barbed Male Nipple (1 piece)  
Barbed Female Nipple (2 pieces), Spike (1 piece)



# MİNİSPRİNKLER VE EK PARÇALARI / MINISPRINKLERS & FITTINGS

KOD CODE	EBAT / SIZE d x g	AMBALAJ ADEDİ PACKING QUANTITY	KOLİ ADEDİ BOX QUANTITY
31076	Ø7 x Ø6	1000	36000

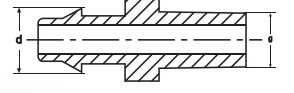

**KURTAĞZI ERKEK NİPEL**  
BARBED MALE NIPPLE

KOD CODE	EBAT / SIZE d x g	AMBALAJ ADEDİ PACKING QUANTITY	KOLİ ADEDİ BOX QUANTITY
32076	Ø7 x Ø6	1000	32000

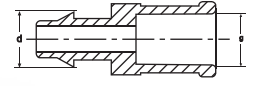

**KURTAĞZI DIŞI NİPEL**  
BARBED FEMALE NIPPLE

KOD CODE	EBAT / SIZE d x d	AMBALAJ ADEDİ PACKING QUANTITY	KOLİ ADEDİ BOX QUANTITY
33077	Ø7 x Ø7	1000	36000

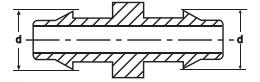

**KURTAĞZI NİPEL**  
BARBED NIPPLE

KOD CODE	EBAT / SIZE d	AMBALAJ ADEDİ PACKING QUANTITY	KOLİ ADEDİ BOX QUANTITY
34070	Ø7	1000	60000

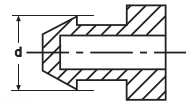

**KURTAĞZI KÖR TAPA**  
BARBED END CAP

# MİNİSPRİNKLER VE EK PARÇALARI / MINISPRINKLERS & FITTINGS

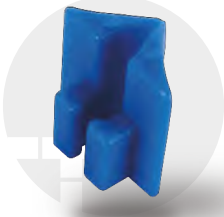

**GÖVDE KORUYUCU**  
BODY PROTECTOR

KOD CODE	EBAT SIZE-mm	AMBALAJ ADEDİ PACKING QUANTITY	KOLİ ADEDİ BOX QUANTITY
30000	-	1000	30000

KOD CODE	EBAT SIZE-mm	AMBALAJ ADEDİ PACKING QUANTITY	KOLİ ADEDİ BOX QUANTITY
30350	350	25	400
30750	750	25	150



**MİNİSPİNK KAZIĞI**  
MINISPRINK SPIKE



**KAZIK BAŞLIĞI**  
ROD ADAPTOR

KOD CODE	EBAT SIZE-mm	AMBALAJ ADEDİ PACKING QUANTITY	KOLİ ADEDİ BOX QUANTITY
30607	6 x 7	100	2000
30611	6 x 11	100	2000

KOD CODE	EBAT SIZE-mm	AMBALAJ ADEDİ PACKING QUANTITY	KOLİ ADEDİ BOX QUANTITY
30807	8 x 7	100	1800
30811	8 x 11	100	2000



**KAZIK BAŞLIĞI**  
ROD ADAPTOR



**MONTAJLI PVC SPAGETTİ BORU**  
ASSEMBLED PVC SPAGHETTI TUBE

KOD CODE	EBAT SIZE-cm	AMBALAJ ADEDİ PACKING QUANTITY	KOLİ ADEDİ BOX QUANTITY
21907	90	25	200

KOD CODE	DIŞ ÇAP EXTERNAL DIAMETER (mm)	İÇ ÇAP INNER DIAMETER (mm)	ET KALINLIĞI WALL THICKNESS (mm)	AMBALAJ M/RULO PACKING m/coil
21707	7	4.5	1.25	100



**SPAGETTİ BORU**  
SPAGHETTI TUBE

# MİNİSPRİNKLER MONTAJ YÖNTEMİ

## MINISPRINKLERS INSTALLATION METHOD

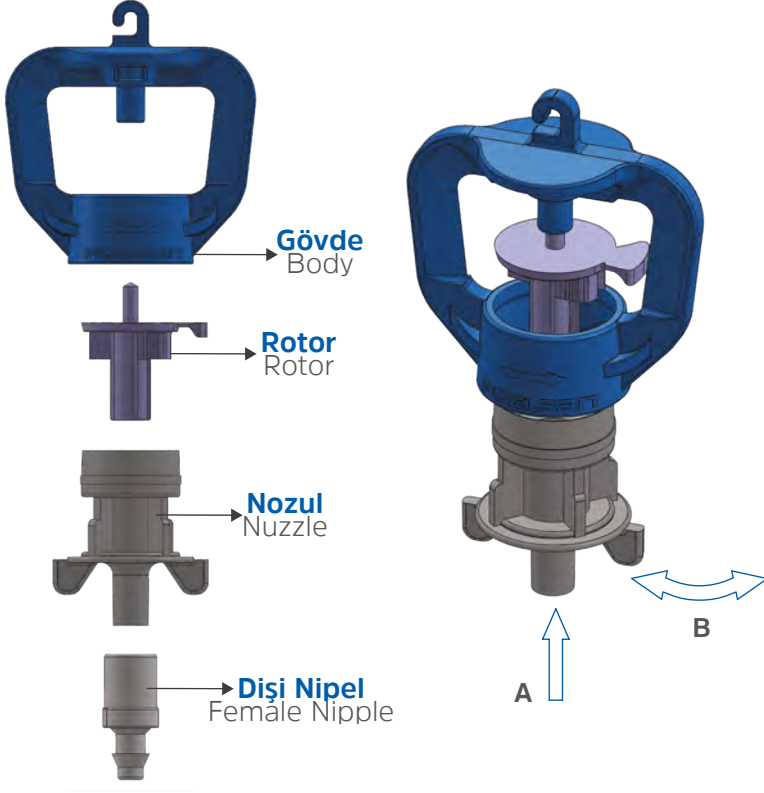

- + Gövde federleri, nozul federleri ile paralel olacak şekilde A yönünde montajı yapılmalıdır.
- + B yönünde gövde federleri ve nozul federleri 90° olacak şekilde çevrilerek demontajı yapılmalıdır.
- + It is assembled in the direction of A with the body tie pieces, and nozzle tie pieces parallel.
- + It is disassembled by turning the body tie pieces, and nozzle tie pieces 90 degrees in the direction of B.

## MİNİSPRİNKLER & EK PARÇALARI

### MINISPRINKLERS & FITTINGS

#### DİKKAT EDİLMESİ GEREKEN HUSUSLAR

- + Ø7 mm Kurtağzı ucu Alçak Yoğunluklu Polietilen (AYPE) boruya takmak için boru Ø3 mm delinmelidir.
- + Henüz fidan halinde olan bitkiler için tırnaklı rotor tipi Minisprinklerin kullanılması daha verimli olacaktır. Büyüyen fidanlarda ise geniş alan sulaması gerektirdiği için rotor üzerinde bulunan tırnak kesilerek kullanılır.

#### POINTS TO TAKE INTO CONSIDERATION

- + For the installation of the Ø7 mm barbed end to the Low Density Polyethylene Pipe (LDPE), the pipe should be punched Ø3 mm.
- + Using Rotating Minisprinklers with the deflector on the rotor will be more efficient for young plants. Bigger plants need a wide scaled irrigation, therefore Minisprinklers are used by fracturing the deflectors on the rotor.

## HAT ÜSTÜ DAMLATICI

ON - LINE DRIPPER

### Özellikler

- + Kullanım alanlarında **montaj kolaylığı sağlar.**
- + Ø16 mm, Ø20 mm, Ø25 mm ve Ø32 mm **Alçak Yoğunluklu Polietilen (AYPE) Borularda (Düz Damla Sulama Boruları) kullanılır.**
- + **Mikrofittingler** ile birlikte Ø7 mm **Spagetti borularda** kullanılır.
- + **Damlatıcının kapağı kolay sökülüp takılabilir** şekilde olması damlatıcının temizlenmesi işlemini kolaylaştırır.

### Specifications

- + On - Line Drippers provide **easy installation.**
- + On - Line Drippers are used in Ø16 mm, Ø20 mm, Ø25 mm and Ø32 mm **Low Density Polyethylene Pipe (LDPE) (Flat Drip Irrigation Pipe).**
- + **On - Line Drippers** are used in Ø7 mm **Spaghetti Tube** together with Microfittings.
- + **The simple demountable cover of dripper** facilitates the cleaning process.



### KULLANIM ALANLARI

- + Peyzaj Sektörü
- + Çiçek ve Sebze Bahçeleri
- + Fidanlıklar
- + Meyve Ağaçları
- + Seralar
- + Bahçe Sulamaları
- + Saksı Sulamaları

### INSTALLATION AREAS

- + Landscaping Systems
- + Flower and Vegetables Gardens
- + Plantations
- + Fruit Trees
- + Greenhouses
- + Garden Irrigations
- + Pot Irrigations

# HAT ÜSTÜ DAMLATICI / ON - LINE DRIPPER

KOD CODE	TİP TYPE (lt/h)	AMBALAJ ADEDİ PACKING QUANTITY	KOLİ ADEDİ BOX QUANTITY
40070	0-70	100	8000

KLİK CLICK	BOŞALTIM DEĞERİ DISCHARGE (lt/h)					
	0.5 bar	1.0 bar	1.5 bar	2.0 bar	2.5 bar	3.0 bar
2	4.0	9.8	12.2	15.2	17.3	20.2
8	9.9	15.7	22.8	26.4	27.9	33.0
12	18.7	30.0	38.9	45.1	49.7	57.0
16 (1 Tam tur) (Full round)	25.4	38.9	53.1	60.4	68.1	75.7
20	29.6	45.0	61.8	69.7	78.9	88.4
24	33.9	52.4	71.2	78.0	90.5	101.0



**DEBİ AYARLI HAT ÜSTÜ DAMLATICI**  
FLOW ADJUSTABLE ON - LINE DRIPPERS

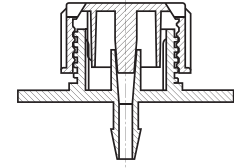
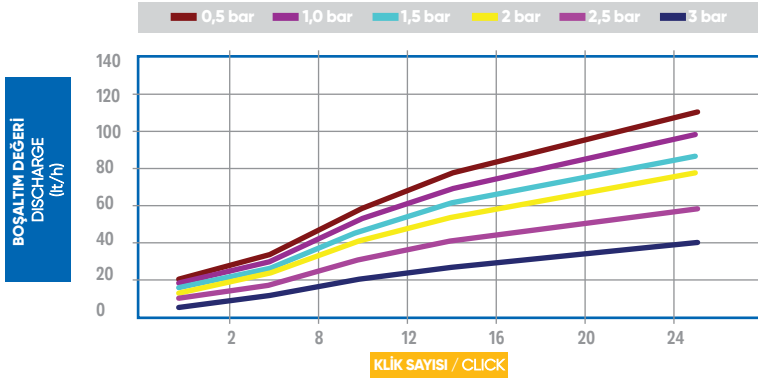

KOD CODE	TİP TYPE (lt/h)	AMBALAJ ADEDİ PACKING QUANTITY	KOLİ ADEDİ BOX QUANTITY
40100	0-100	100	4000

KLİK CLICK	BOŞALTIM DEĞERİ DISCHARGE (lt/h)					
	0.5 bar	1.0 bar	1.5 bar	2.0 bar	2.5 bar	3.0 bar
2	0.3	0.4	0.5	0.6	0.8	1.0
8	9.6	15.2	19.0	21.8	25.4	30.1
12	13.7	22.3	28.3	33.6	37.9	42.6
16 (1 Tam tur) (Full round)	31.0	48.2	62.5	72.3	79.6	84.7
20	56.2	84.9	110.9	125.7	137.7	146.0
24	81.7	116.5	147.6	172.5	187.8	206.3
28	84.8	122.9	153.4	179.0	202.4	216.4
32	86.0	125.3	154.1	179.4	202.9	217.3



**DEBİ AYARLI HAT ÜSTÜ DAMLATICI**  
FLOW ADJUSTABLE ON - LINE DRIPPERS

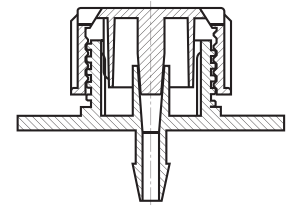
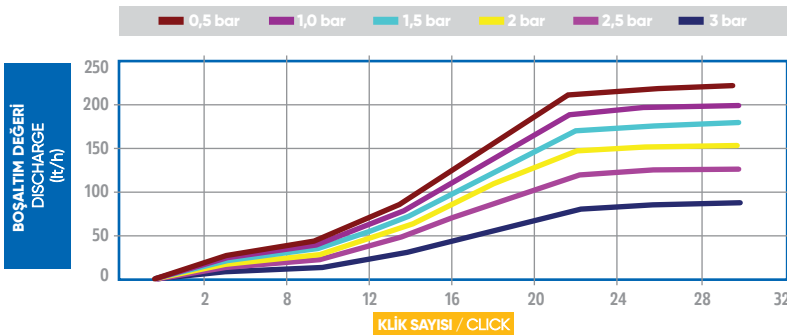

# HAT ÜSTÜ DAMLATICILAR

## ON - LINE DRIPPERS

### DİKKAT EDİLMESİ GEREKEN HUSUSLAR

- + Hat Üstü Damlatıcı, boru üzerine delme aparatı ile çapı 3 mm olacak şekilde delik delinerek kolayca takılır.
- + Sistemde kullanılacak filtrenin minimum süzme kapasitesi 125 mikron olmalıdır.

### POINTS TO TAKE INTO CONSIDERATION

- + On - Line Drippers are easily inserted by punching a 3 mm hole on the pipe.
- + The minimum filtration capacity of the filter used in the system shall be 125 microns.



**RURAL EK PARÇALAR**  
RURAL FITTINGS

---



**RURAL KÜRESEL VANA**  
RURAL BALL VALVES

---



**ÖZEL ÜRETİM**  
(SPECIAL PRODUCTION)  
**RURAL EK PARÇALAR**  
RURAL FITTINGS

## Özellikler

- + Darbelere karşı dayanıklı, yüksek kaliteli polipropilen hammaddeden üretilmiştir.
- + UV ışınlarını geçirmediği için yosunlanmaya ve bakteri üremesine izin vermez.
- + Oringi kauçuktan üretilmekte olup yüksek basınç altında sızdırmazlık sağlar.
- + İç yüzeyleri homojen ve gözeneksizdir.
- + Suyun kokusunu ve tadını değiştirebilecek zararlı bileşikler içermez.

## Specifications

- + It has been produced from high quality polypropylene raw material and it has resistance to impact.
- + They prevent alga and bacteria forming due to UV proof (ultraviolet beam) structure.
- + O-rings are made of rubber and provide leakproofness under high pressure.
- + It has a homogeneous and non-porous inner surface.
- + It does not contain any harmful compounds which can change the taste or the smell of the water.

**GARANTİ VERİLEN BASINÇ DEĞERİ : PN 10**  
**GUARANTEED PRESSURE VALUE : PN 10**

### KULLANIM ALANLARI

- + Tarımsal Sulama
- + Seralar

### INSTALLATION AREAS

- + Agricultural Irrigation
- + Greenhouses



# RURAL EK PARÇALAR / RURAL FITTINGS

KOD CODE	EBAT / SIZE d x G	BASINÇ DEĞERİ PRESSURE VALUE PN	AMBALAJ ADEDİ PACKING QUANTITY	KOLİ ADEDİ BOX QUANTITY
20011	20 (¾") x ½"	10	50	500
20012	20 (¾") x ¾"	10	50	500
20021	25 (1") x ½"	10	25	350
20022	25 (1") x ¾"	10	25	350
20023	25 (1") x 1"	10	25	350
20031	32 (1 ¼") x ½"	10	25	225
20032	32 (1 ¼") x ¾"	10	25	200
20033	32 (1 ¼") x 1"	10	25	200
20034	32 (1 ¼") x 1 ¼"	10	25	200
20043	40 (1 ½") x 1"	10	15	120
20044	40 (1 ½") x 1 ¼"	10	15	120
20045	40 (1 ½") x 1 ½"	10	15	120
20054	50 (2") x 1 ¼"	10	10	80
20055	50 (2") x 1 ½"	10	10	70
20056	50 (2") x 2"	10	10	80



**ERKEK ADAPTÖR**  
MALE ADAPTOR

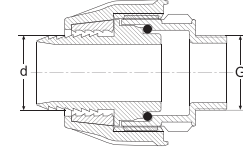

KOD CODE	EBAT / SIZE d x G	BASINÇ DEĞERİ PRESSURE VALUE PN	AMBALAJ ADEDİ PACKING QUANTITY	KOLİ ADEDİ BOX QUANTITY
20111	20 (¾") x ½"	10	50	500
20112	20 (¾") x ¾"	10	50	500
20121	25 (1") x ½"	10	25	350
20122	25 (1") x ¾"	10	25	350
20123	25 (1") x 1"	10	25	300
20132	32 (1 ¼") x ¾"	10	25	225
20133	32 (1 ¼") x 1"	10	25	225
20134	32 (1 ¼") x 1 ¼"	10	25	150
20143	40 (1 ½") x 1"	10	15	90
20144	40 (1 ½") x 1 ¼"	10	15	90
20145	40 (1 ½") x 1 ½"	10	15	105
20154	50 (2") x 1 ¼"	10	10	80
20155	50 (2") x 1 ½"	10	10	80
20156	50 (2") x 2"	10	10	70



**DIŞİ ADAPTÖR**  
FEMALE ADAPTOR

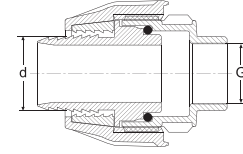

KOD CODE	EBAT / SIZE d x d	BASINÇ DEĞERİ PRESSURE VALUE PN	AMBALAJ ADEDİ PACKING QUANTITY	KOLİ ADEDİ BOX QUANTITY
20211	20 (¾") x 20 (¾")	10	25	300
20222	25 (1") x 25 (1")	10	25	200
20233	32 (1 ¼") x 32 (1 ¼")	10	10	120
20244	40 (1 ½") x 40 (1 ½")	10	10	60
20255	50 (2") x 50 (2")	10	6	36



**MANŞON**  
COUPLING

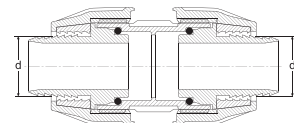

# RURAL EK PARÇALAR / RURAL FITTINGS



**TE**  
TEE

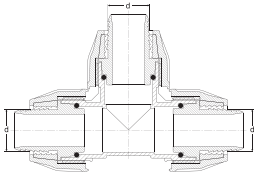

**ERKEK TE**  
MALE TEE

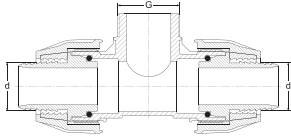

**DIŞİ TE**  
FEMALE TEE

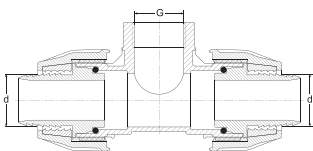

KOD CODE	EBAT / SIZE d x d x d	BASINÇ DEĞERİ PRESSURE VALUE PN	AMBALAJ ADEDİ PACKING QUANTITY	KOLİ ADEDİ BOX QUANTITY
20511	20 (¾") x 20 (¾") x 20 (¾")	10	15	180
20522	25 (1") x 25 (1") x 25 (1")	10	10	120
20533	32 (1 ¼") x 32 (1 ¼") x 32 (1 ¼")	10	5	75
20544	40 (1 ½") x 40 (1 ½") x 40 (1 ½")	10	5	40
20555	50 (2") x 50 (2") x 50 (2")	10	4	28

KOD CODE	EBAT / SIZE d x G x d	BASINÇ DEĞERİ PRESSURE VALUE PN	AMBALAJ ADEDİ PACKING QUANTITY	KOLİ ADEDİ BOX QUANTITY
20611	20 (¾") x ½" x 20 (¾")	10	15	210
20612	20 (¾") x ¾" x 20 (¾")	10	15	240
20621	25 (1") x ½" x 25 (1")	10	10	160
20622	25 (1") x ¾" x 25 (1")	10	10	160
20623	25 (1") x 1" x 25 (1")	10	10	140
20624	25 (1") x 1 ¼" x 25 (1")	10	10	120
20632	32 (1 ¼") x ¾" x 32 (1 ¼")	10	10	90
20633	32 (1 ¼") x 1" x 32 (1 ¼")	10	10	90
20634	32 (1 ¼") x 1 ¼" x 32 (1 ¼")	10	10	90
20643	40 (1 ½") x 1" x 40 (1 ½")	10	5	55
20644	40 (1 ½") x 1 ¼" x 40 (1 ½")	10	5	50
20645	40 (1 ½") x 1 ½" x 40 (1 ½")	10	5	50
20653	50 (2") x 1" x 50 (2")	10	4	36
20654	50 (2") x 1 ¼" x 50 (2")	10	4	36
20655	50 (2") x 1 ½" x 50 (2")	10	4	36
20656	50 (2") x 2" x 50 (2")	10	4	32

KOD CODE	EBAT / SIZE d x G x d	BASINÇ DEĞERİ PRESSURE VALUE PN	AMBALAJ ADEDİ PACKING QUANTITY	KOLİ ADEDİ BOX QUANTITY
20711	20 (¾") x ½" x 20 (¾")	10	15	210
20712	20 (¾") x ¾" x 20 (¾")	10	15	225
20721	25 (1") x ½" x 25 (1")	10	10	180
20722	25 (1") x ¾" x 25 (1")	10	10	160
20723	25 (1") x 1" x 25 (1")	10	10	140
20731	32 (1 ¼") x ½" x 32 (1 ¼")	10	10	90
20732	32 (1 ¼") x ¾" x 32 (1 ¼")	10	10	90
20733	32 (1 ¼") x 1" x 32 (1 ¼")	10	10	90
20734	32 (1 ¼") x 1 ¼" x 32 (1 ¼")	10	10	80
20742	40 (1 ½") x ¾" x 40 (1 ½")	10	5	60
20743	40 (1 ½") x 1" x 40 (1 ½")	10	5	55
20744	40 (1 ½") x 1 ¼" x 40 (1 ½")	10	5	50
20745	40 (1 ½") x 1 ½" x 40 (1 ½")	10	5	45
20755	50 (2") x 1 ½" x 50 (2")	10	4	32
20756	50 (2") x 2" x 50 (2")	10	4	28

## RURAL EK PARÇALAR / RURAL FITTINGS

KOD CODE	EBAT / SIZE d x d	BASINÇ DEĞERİ PRESSURE VALUE PN	AMBALAJ ADEDİ PACKING QUANTITY	KOLİ ADEDİ BOX QUANTITY
21011	20 (¾") x 20 (¾")	10	25	300
21022	25 (1") x 25 (1")	10	15	180
21033	32 (1 ¼") x 32 (1 ¼")	10	10	110
21044	40 (1 ½") x 40 (1 ½")	10	5	60
21055	50 (2") x 50 (2")	10	4	40



**DİRSEK**  
ELBOW

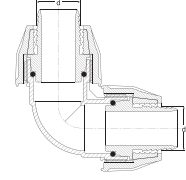

KOD CODE	EBAT / SIZE d x G	BASINÇ DEĞERİ PRESSURE VALUE PN	AMBALAJ ADEDİ PACKING QUANTITY	KOLİ ADEDİ BOX QUANTITY
21111	20 (¾") x ½"	10	25	450
21112	20 (¾") x ¾"	10	25	400
21121	25 (1") x ½"	10	15	300
21122	25 (1") x ¾"	10	15	300
21123	25 (1") x 1"	10	15	270
21132	32 (1 ¼") x ¾"	10	10	180
21133	32 (1 ¼") x 1"	10	10	180
21134	32 (1 ¼") x 1 ¼"	10	10	150
21143	40 (1 ½") x 1"	10	5	110
21144	40 (1 ½") x 1 ¼"	10	5	110
21145	40 (1 ½") x 1 ½"	10	5	90
21155	50 (2") x 1 ½"	10	4	64
21156	50 (2") x 2"	10	4	56



**ERKEK DİRSEK**  
MALE ELBOW

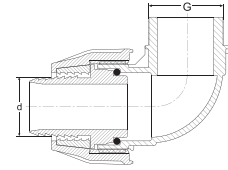

KOD CODE	EBAT / SIZE d x G	BASINÇ DEĞERİ PRESSURE VALUE PN	AMBALAJ ADEDİ PACKING QUANTITY	KOLİ ADEDİ BOX QUANTITY
21211	20 (¾") x ½"	10	25	500
21212	20 (¾") x ¾"	10	25	400
21221	25 (1") x ½"	10	15	330
21222	25 (1") x ¾"	10	15	300
21223	25 (1") x 1"	10	15	240
21232	32 (1 ¼") x ¾"	10	10	180
21233	32 (1 ¼") x 1"	10	10	170
21234	32 (1 ¼") x 1 ¼"	10	10	140
21243	40 (1 ½") x 1"	10	5	110
21244	40 (1 ½") x 1 ¼"	10	5	100
21245	40 (1 ½") x 1 ½"	10	5	70
21254	50 (2") x 1 ¼"	10	4	64
21255	50 (2") x 1 ½"	10	4	60
21256	50 (2") x 2"	10	4	52



**DIŞİ DİRSEK**  
FEMALE ELBOW

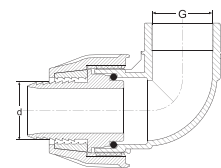

## RURAL EK PARÇALAR / RURAL FITTINGS



**REDÜKSİYON TE**  
REDUCING TEE

KOD CODE	EBAT / SIZE d x d <sub>1</sub> x d	BASINÇ DEĞERİ PRESSURE VALUE PN	AMBALAJ ADEDİ PACKING QUANTITY	KOLİ ADEDİ BOX QUANTITY
<b>21312</b>	<b>20 (¾") x 25 (1") x 20 (¾")</b>	<b>10</b>	<b>10</b>	<b>160</b>
21321	25 (1") x 20 (¾") x 25 (1")	10	10	140
<b>21323</b>	<b>25 (1") x 32 (1 ¼") x 25 (1")</b>	<b>10</b>	<b>10</b>	<b>90</b>
21331	32 (1 ¼") x 20 (¾") x 32 (1 ¼")	10	5	90
<b>21332</b>	<b>32 (1 ¼") x 25 (1") x 32 (1 ¼")</b>	<b>10</b>	<b>5</b>	<b>80</b>
21342	40 (1 ½") x 25 (1") x 40 (1 ½")	10	5	55
<b>21343</b>	<b>40 (1 ½") x 32 (1 ¼") x 40 (1 ½")</b>	<b>10</b>	<b>5</b>	<b>45</b>
21352	50 (2") x 25 (1") x 50 (2")	10	4	28
<b>21353</b>	<b>50 (2") x 32 (1 ¼") x 50 (2")</b>	<b>10</b>	<b>4</b>	<b>28</b>
21354	50 (2") x 40 (1 ½") x 50 (2")	10	4	28

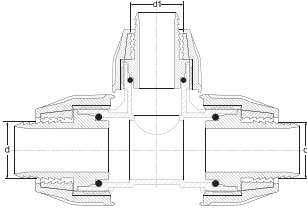

**REDÜKSİYON MANŞON**  
REDUCING COUPLING

KOD CODE	EBAT / SIZE d x d <sub>1</sub>	BASINÇ DEĞERİ PRESSURE VALUE PN	AMBALAJ ADEDİ PACKING QUANTITY	KOLİ ADEDİ BOX QUANTITY
<b>21421</b>	<b>25 (1") x 20 (¾")</b>	<b>10</b>	<b>25</b>	<b>250</b>
21431	32 (1 ¼") x 20 (¾")	10	10	180
<b>21432</b>	<b>32 (1 ¼") x 25 (1")</b>	<b>10</b>	<b>10</b>	<b>150</b>
21441	40 (1 ½") x 20 (¾")	10	10	110
<b>21442</b>	<b>40 (1 ½") x 25 (1")</b>	<b>10</b>	<b>10</b>	<b>100</b>
21443	40 (1 ½") x 32 (1 ¼")	10	10	90
<b>21452</b>	<b>50 (2") x 25 (1")</b>	<b>10</b>	<b>6</b>	<b>72</b>
21453	50 (2") x 32 (1 ¼")	10	6	60
<b>21454</b>	<b>50 (2") x 40 (1 ½")</b>	<b>10</b>	<b>6</b>	<b>54</b>

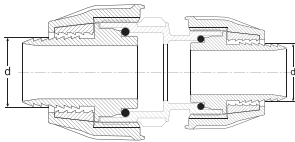



## RURAL EK PARÇALAR / RURAL FITTINGS

KOD CODE	EBAT / SIZE d x d <sub>1</sub>	BASINÇ DEĞERİ PRESSURE VALUE PN	AMBALAJ ADEDİ PACKING QUANTITY	KOLİ ADEDİ BOX QUANTITY
21621	25 (1") x 20 (¾")	10	15	210
21632	32 (1 ¼") x 25 (1")	10	10	140
21643	40 (1 ½") x 32 (1 ¼")	10	5	80
21654	50 (2") x 40 (1 ½")	10	4	48



**REDÜKSİYON DİRSEK**  
REDUCING ELBOW

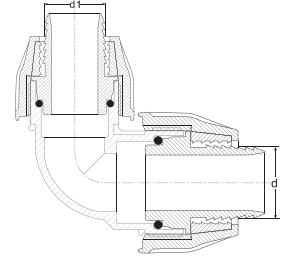

KOD CODE	EBAT / SIZE d	BASINÇ DEĞERİ PRESSURE VALUE PN	AMBALAJ ADEDİ PACKING QUANTITY	KOLİ ADEDİ BOX QUANTITY
21511	20 (¾")	10	50	650
21522	25 (1")	10	25	400
21533	32 (1 ¼")	10	25	225
21544	40 (1 ½")	10	15	150
21555	50 (2")	10	12	84



**KÖR TAPA**  
END CAP

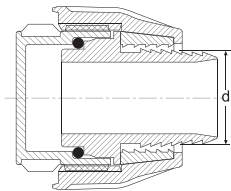

# ÖZEL ÜRETİM

(SPECIAL PRODUCTION)

## RURAL EK PARÇALAR

RURAL FITTINGS

### DİKKAT EDİLMESİ GEREKEN HUSUSLAR

- +Rural borular, ingiliz birim sistemine (inç) göre üretilmiştir. Ölçü farklılığı sebebiyle Rural Ek Parçaların metrik sisteme (mm) göre üretilen borularda kullanımı uygun değildir.
- +İç tutucu gövde içerisine montajlanırken oringin yerinde olmasına dikkat edilmelidir.
- +Boru uçları düz kesilmelidir.

### POINTS TO TAKE INTO CONSIDERATION

- +Rural pipes are produced with British unit of measure (inch), it is not appropriate to use Rural Fittings with the pipes produced with metric system, because of measure difference.
- +While assembling the inner holder inside the body, it should be paid attention that the o-ring is in the right place.
- +Pipe ends should be cut straightly.

**ÖZEL ÜRETİM**  
(SPECIAL PRODUCTION)  
**RURAL KÜRESEL VANA**  
RURAL BALL VALVES

## Özellikler

- + Darbelere karşı dayanıklı, yüksek kaliteli polipropilen hammaddeden üretilmiştir.
- + Vananın her iki yönünden de akış sağlamak mümkündür.
- + Akışkan geçişinde basınç ve debi kaybına sebep olmaz.
- + Sisteminizde kolay montaj imkânı sağlar.
- + Oring kauçuktan üretilmekte olup yüksek basınç altında sızdırmazlık sağlar.
- + Suyun kokusunu ve tadını değiştirebilecek zararlı bileşikler içermez.

## Specifications

- + It has been produced from high quality polypropylene raw material and it has resistance to impact.
- + It is possible to provide bidirectional flow in the valve.
- + They do not cause any pressure or flow loss during fluid pass.
- + They supply easy installation in your system.
- + O-rings are made of rubber and provide leakproofness under high pressure.
- + It does not contain any harmful compounds which can change the taste or the smell of the water.

**GARANTİ VERİLEN BASINÇ DEĞERİ : PN 10**  
**GUARANTEED PRESSURE VALUE : PN 10**

### KULLANIM ALANLARI

- + Peyzaj Sektörü
- + Tarımsal Sulama

### INSTALLATION AREAS

- + Landscaping Systems
- + Agricultural Irrigation



# RURAL KÜRESEL VANA / RURAL BALL VALVES



KOD CODE	EBAT / SIZE G x d	BASINÇ DEĞERİ PRESSURE VALUE PN	AMBALAJ ADEDİ PACKING QUANTITY	KOLİ ADEDİ BOX QUANTITY
99634	1" x 40 (1 1/2")	10	4	48
99644	1 1/4" x 40 (1 1/2")	10	4	48
99645	1 1/4" x 50 (2")	10	2	28
99655	1 1/2" x 50 (2")	10	2	26

## RURAL KÜRESEL VANA ERKEK - KABLİN RURAL BALL VALVE MALE - COUPLING

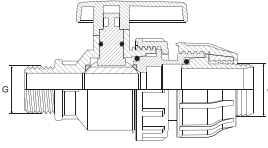

KOD CODE	EBAT / SIZE d x D	BASINÇ DEĞERİ PRESSURE VALUE PN	AMBALAJ ADEDİ PACKING QUANTITY	KOLİ ADEDİ BOX QUANTITY
99732	32 (1 1/4") x 3/4"	10	4	100
99733	32 (1 1/4") x 1"	10	4	96
99743	40 (1 1/2") x 1"	10	4	48
99744	40 (1 1/2") x 1 1/4"	10	4	48
99754	50 (2") x 1 1/4"	10	2	32
99755	50 (2") x 1 1/2"	10	2	32

## RURAL KÜRESEL VANA KABLİN - DIŞI RURAL BALL VALVE COUPLING - FEMALE

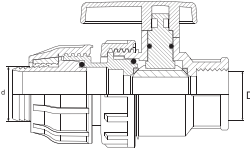

KOD CODE	EBAT / SIZE d x d	BASINÇ DEĞERİ PRESSURE VALUE PN	AMBALAJ ADEDİ PACKING QUANTITY	KOLİ ADEDİ BOX QUANTITY
99844	40 (1 1/2") x 40 (1 1/2")	10	4	36
99855	50 (2") x 50 (2")	10	2	24

## RURAL KÜRESEL VANA KABLİN - KABLİN RURAL BALL VALVE COUPLING - COUPLING

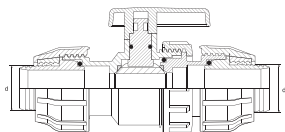

# ÖZEL ÜRETİM

(SPECIAL PRODUCTION)

## RURAL KÜRESEL VANA

RURAL BALL VALVES

### DİKKAT EDİLMESİ GEREKEN HUSUSLAR

- + Kullanılacak sistemde Filtre kullanılmalıdır.
- + Filtre kullanılmayan durumlarda vana içerisindeki parçalar zarar görebilir, çalışma ömrü kısalmır.
- + Vanalar sökülüp takılabilen parçalardan meydana gelmektedir. Sökülen parçaların tekrar yerine doğru montajı yapılmalıdır.
- + Dişli kısımların montajında teflon vb. sızdırmazlık elemanı kullanılmalıdır.
- + Küresel vanalar su dışındaki akışkanlar için kullanıma uygun değildir.
- + Rural borular, İngiliz birim sistemine (inç) göre üretilmiştir. Ölçü farklılığı sebebiyle Rural Ek Parçaların metrik sisteme (mm) göre üretilen borularda kullanımı uygun değildir.
- + İç tutucu gövde içerisine montajlanırken oringin yerinde olmasına dikkat edilmelidir.
- + Boru uçları düz kesilmelidir.

### POINTS TO TAKE INTO CONSIDERATION

- + The filter should be used in the system.
- + When the filter is not used, the parts inside the valve may be damaged, and the working life will be shortened.
- + Valves consist of parts that can be disassembled, and assembled. The dismantled parts must be assembled correctly.
- + Sealing elements such as Teflon etc. should be used in the assembly of the threaded parts.
- + Ball valves are not suitable for fluids other than water.
- + Rural pipes are produced according to the British unit system (inch). Rural Fittings are not suitable for the pipes produced according to the metric system (mm) due to the difference in size.
- + While assembling the inner holder inside the body, it should be paid attention that the o-ring is in the right place.
- + Pipe ends should be cut straightly.

# SERTİFİKALARIMIZ / CERTIFICATES



**MARKA TESCİL BELGESİ**  
BRAND REGISTRATION



**KALİTE YÖNETİM BELGESİ**  
QUALITY MANAGEMENT  
SYSTEM CERTIFICATE



**ÇEVRE YÖNETİM BELGESİ**  
ENVIRONMENT MANAGEMENT  
SYSTEM CERTIFICATE



**İŞ SAĞLIĞI GÜVENLİĞİ**  
OCCUPATIONAL HEALTH &  
SAFETY MANAGEMENT SYSTEM  
CERTIFICATE



**YENİ MAVİ SERİ**  
**AMERİKA PATENTİ**  
NEW BLUE SERIES  
USA DESIGN PATENT



**KIWA BELGESİ**  
KIWA CERTIFICATE



**MAVİ SERİ**  
**TASARIM TESCİL BELGESİ**  
BLUE SERIES - DESIGN  
REGISTRATION CERTIFICATE



**YENİ MAVİ SERİ**  
**TASARIM TESCİL**  
NEW BLUE SERIES - DESIGN  
REGISTRATION CERTIFICATE



**YENİ PRİZ KOLYE**  
**TASARIM TESCİL**  
NEW CLAMP SADDLE  
DESIGN REGISTRATION  
CERTIFICATE



**YENİ YEŞİL SERİ**  
**TASARIM TESCİL**  
NEW GREEN SERIES - DESIGN  
REGISTRATION CERTIFICATE

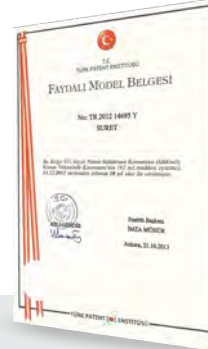

**ESNEK BORU TUTUCULAR**  
**FAYDALI MODEL BELGESİ**  
UTILITY MODEL CERTIFICATE  
FLEXIBLE O-RING HOLDERS



**TS ISO 17885 TÜRK**  
**STANDARTLARINA UYGUNLUK**  
TSE ISO 17885 Certificate Of  
Conformity to TSE



**TS ISO 13460-1 TÜRK**  
**STANDARTLARINA UYGUNLUK**  
TSE ISO 13460-1 Certificate  
Of Conformity to TSE



**TS ISO 24649 VANALAR TSE**  
**KRİTERLERİNE UYGUNLUK**  
TS ISO 24649 Valves Certificate  
Of Conformity to TSE



**TS ISO 9261 TÜRK**  
**STANDARTLARINA UYGUNLUK**  
TS ISO 9261 Certificate  
Of Conformity to TSE



**TS 13716 VANA KUTULARI TÜRK**  
**STANDARTLARINA UYGUNLUK**  
TS 13716 Valve Boxes Certificate  
Of Conformity to TSE



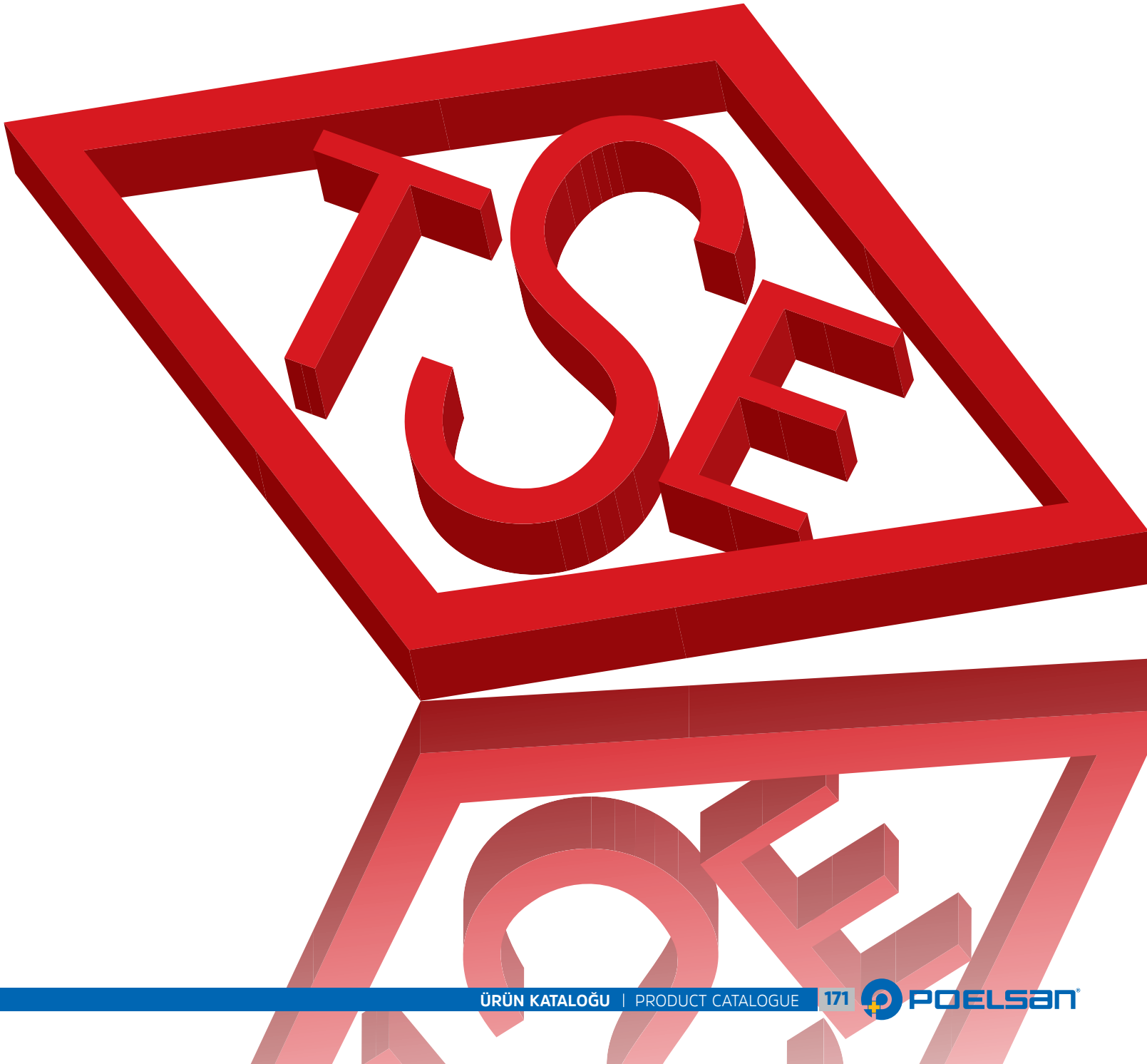

# AMBALAJ BİLGİLERİMİZ / PACKAGE INFORMATION



## Koli Kullanılan Ürün Grupları

Mavi Seri  
Mavi Seri Flanşlı Adaptör  
Yeşil Seri  
Can Suyu Vana  
Plastik Filtre  
Priz Kolye Geçmeli  
Layflat Ek Parçaları & Çıkış Nipelleri  
Dişli Bağlantı Elemanları  
Mini Vanalar (DN 8)  
Mini Vanalar (DN 15)  
Hat Sonu Tahliye Vanası  
Damla Sulama Kurtağzı Ek Parçaları  
Yassı Damla Sulama Ek Parçaları  
Yüzlüklü Yassı Damla Sulama Ek Parçaları  
Minisprinkler & Mikrofittingler  
Hat Üstü Damlaticılar  
Priz Kolye  
Manyetik Lokma Ucu  
(16080, 16083)  
Yeşil Seri Küresel Vana  
Mavi Seri Küresel Vana  
Boru Delme Aparatı  
(16096, 16098, 16092, 16094)

## Product Series in Box

Blue Series  
Blue Series Flanged Adaptor  
Green Series  
Quick Coupling Valve  
Plastic Filter  
Clamp Saddles With Slide  
Layflat Fittings & Offtake Nipples  
Threaded Fittings  
Mini Valves (DN 8)  
Mini Valves (DN 15)  
End Line Drain Valve  
Dripline Barbed Fittings  
Drip Tape Fittings  
Drip Tape Fittings With Ring  
Minisprinklers & Microfittings  
On-Line Drippers  
Clamp Saddles  
Magnetic Socket Wrench  
(16080, 16083)  
Green Series Ball Valves  
Blue Series Ball Valves  
Driller  
(16096, 16098, 16092, 16094)

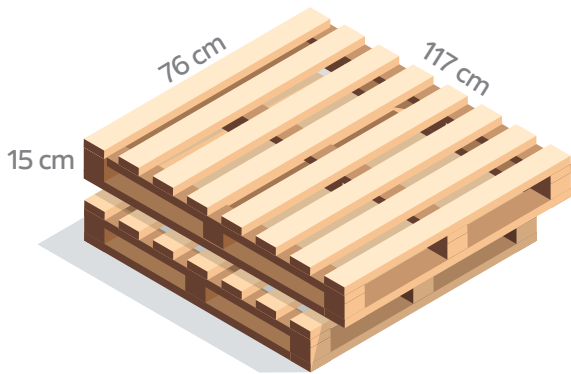

## Palet Kullanılan Ürün Grupları

Vana Kutuları

## Product Series in The Pallet

Valve Boxes

## NOTLAR / NOTES

Blank area for notes, consisting of multiple horizontal lines.

# NOTLAR / NOTES

Blank lined area for notes, consisting of 20 horizontal grey bars.

## NOTLAR / NOTES

Blank area for notes, consisting of multiple horizontal lines.

# NOTLAR / NOTES

Blank lined area for notes, consisting of 20 horizontal grey bars.



## NOTLAR / NOTES



Blank area for notes, consisting of multiple horizontal lines.

# NOTLAR / NOTES

Blank area for notes, consisting of 20 horizontal grey bars.



01/2024

 Merkez | Headquarters  Samsun Şube | Branch  İstanbul Şube | Branch  
Şabanoğlu OSB Mah. Ulubatlı Cad. No: 6, Tekkeköy SAMSUN TÜRKİYE

**Tel:** +90 362 266 75 24

**Faks:** +90 362 266 77 51

[poelsan@poelsan.com](mailto:poelsan@poelsan.com)

**Tel:** +90 362 266 75 27

**GSM:** +90 544 366 69 64

[www.poelsan.com](http://www.poelsan.com)

  | [poelsanplastik](https://www.facebook.com/poelsanplastik)

   | [poelsan](https://www.linkedin.com/company/poelsan)